

# GENERAL INTRODUCTION: RPV

Milan Brumovský



- INTRODUCTION
- RPV DESIGN
- RPV MATERIALS
- RPV MANUFACTURING TECHNOLOGY
- RPV MATERIAL PROPERTIES
- OPEN QUESTIONS
- CONCLUSIONS
- LITERATURE

# INTRODUCTION



# REACTOR PRESSURE VESSEL

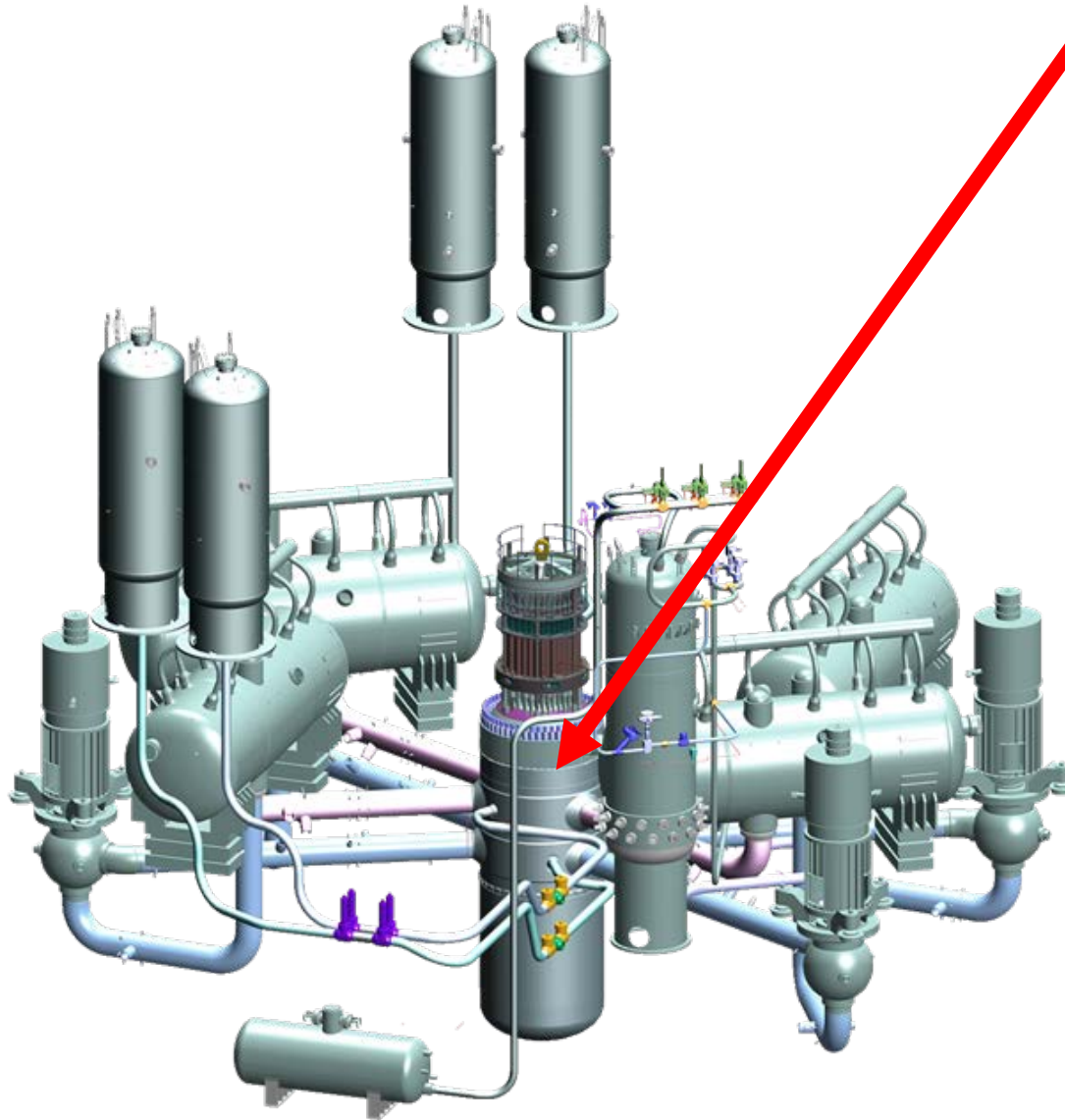

## □ REACTOR PRESSURE VESSELS

- **NUCLEAR REACTION IS REALIZED INSIDE RPV = HEART OF THE NPP**
  - **THUS, RPV IS THE MOST IMPORTANT COMPONENT OF THE WHOLE NPP**
- **RPV CONTAINS ALL NUCLEAR FISSION MATERIALS**
  - **THEIR PRACTICALLY 100 % INTEGRITY MUST BE ASSURED**
- **RPV PRACTICALLY CANNOT BE REPLACED**
  - **DETERMINES LIFETIME OF THE WHOLE NPP**



NEUTRONS	MODERATOR	COOLANT	RPV/TUBES	TYPE
THERMAL	H <sub>2</sub> O	H <sub>2</sub> O	RPV	PWR
				VVER
				BWR
	D <sub>2</sub> O	D <sub>2</sub> O	TUBES	CANDU
	D <sub>2</sub> O	CO <sub>2</sub>	RPV/TUBES	HWGCR = A1
GRAFIT		H <sub>2</sub> O	TUBES	RBMK
		He	TNR	HTR
FAST	-	Na/Pb+Bi	RV	FBR

VVER = WWER IS PWR DESIGNED IN ACCORDANCE WITH RUSSIAN CODES

WWER = WATER-WATER ENERGETICAL REACTOR  
 ВОДО-ВОДЯНОЙ ЭНЕРГЕТИЧЕСКИЙ РЕАКТОР



- ❑ **RPV DESIGN MUST BE PERFORMED WITH RESPECT TO:**
  - **OPERATION CONDITIONS OF REACTOR AND NPP**
    - **REQUIREMENTS TO DESIGN OF ACTIVE CORE AND ALL NPP**
    - **OPERATION PRESSURE AND TEMPERATURE**
    - **REQUIRED LIFETIME**
  - **CURRENT CODES AND STANDARDS**
    - **IN PRINCIPLE: ASME (KTA, RCC-M, JSME) - PNAEG**
  - **TECHNOLOGICAL POSSIBILITIES**
    - **EXISTING/ALLOWED MATERIALS AND MANUFACTURING BASES**
  - **TRANSPORT REQUIREMENTS AND POSSIBILITIES**
    - **LOCATION/SITE OF NPP AND TRANSPORT POSSIBILITIES BETWEEN MANUFACTURER AND NPP**



❑ **RPV MUST ENSURE LONG TERM AND SAFE OPERATION UNDER CONDITIONS OF HIGH PRESSURE, TEMPERATURE AND RADIATION**

❑ **RPV MUST WITHSTAND EFFECTS OF SEVERAL STRESSORS RESULTING FROM OPERATING CONDITIONS**

**PRESSURE: 12 – 18 MPa**

**TEMPERATURE: 270 – 325 °C**

**NEUTRON FLUENCE:  $10^{18}$  –  $2 \times 10^{24}$  m<sup>-2</sup>**

**( $E_n > 1$  MeV)**





## STRESSORS                      AGEING MECHANISMS                      CONSEQUENCES

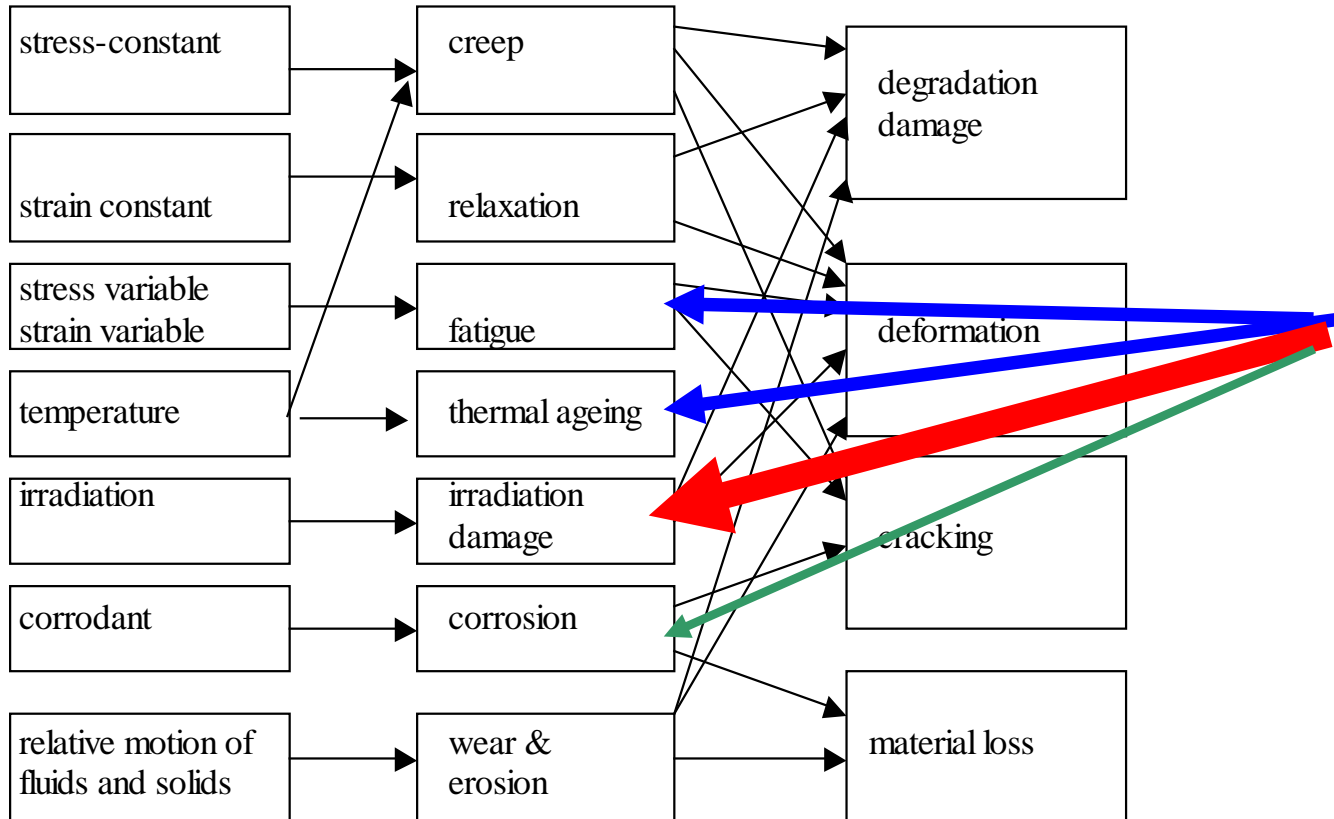

*Ageing factors, basic ageing mechanisms and possible consequences. A major stressor in an ageing structure is time itself. (For example, in the embrittlement of rubber and plastic materials in components)*



## □ HYDROGEN EFFECTS:

- HYDROGEN EMBRITTLEMENT

- USUALLY DUE TO DIFFUSION OF HYDROGEN DURING CORROSION  
– DECREASE IN FRACTURE TOUGHNESS

- DELAYED FRACTURE

- DUE TO ACCUMULATION OF HYDROGEN ON GB etc.

- **HYDROGEN FLAKES**

- HIGH CONTENT OF HYDROGEN THAT WAS NOT REMOVED BY VACUUM POURING AND/OR BY ANTIFLAKE ANNEALING



- ❑ **RPV LIFETIME DEPENDS PRACTICALLY ON RESISTANCE AGAINST BRITTLE/NON-DUCTILE FAILURE THAT IS GOVERNED BY RADIATION DAMAGE OF RPV BELTLINE MATERIALS**
- ❑ **THUS RADIATION EMBRITTLEMENT IS THE MOST IMPORTANT RPV DAMAGE MECHANISM**
- ❑ **RADIATION EMBRITTLEMENT TOGETHER WITH MATERIAL INITIAL PROPERTIES DETERMINES RPV LIFETIME**



# RPV DESIGN



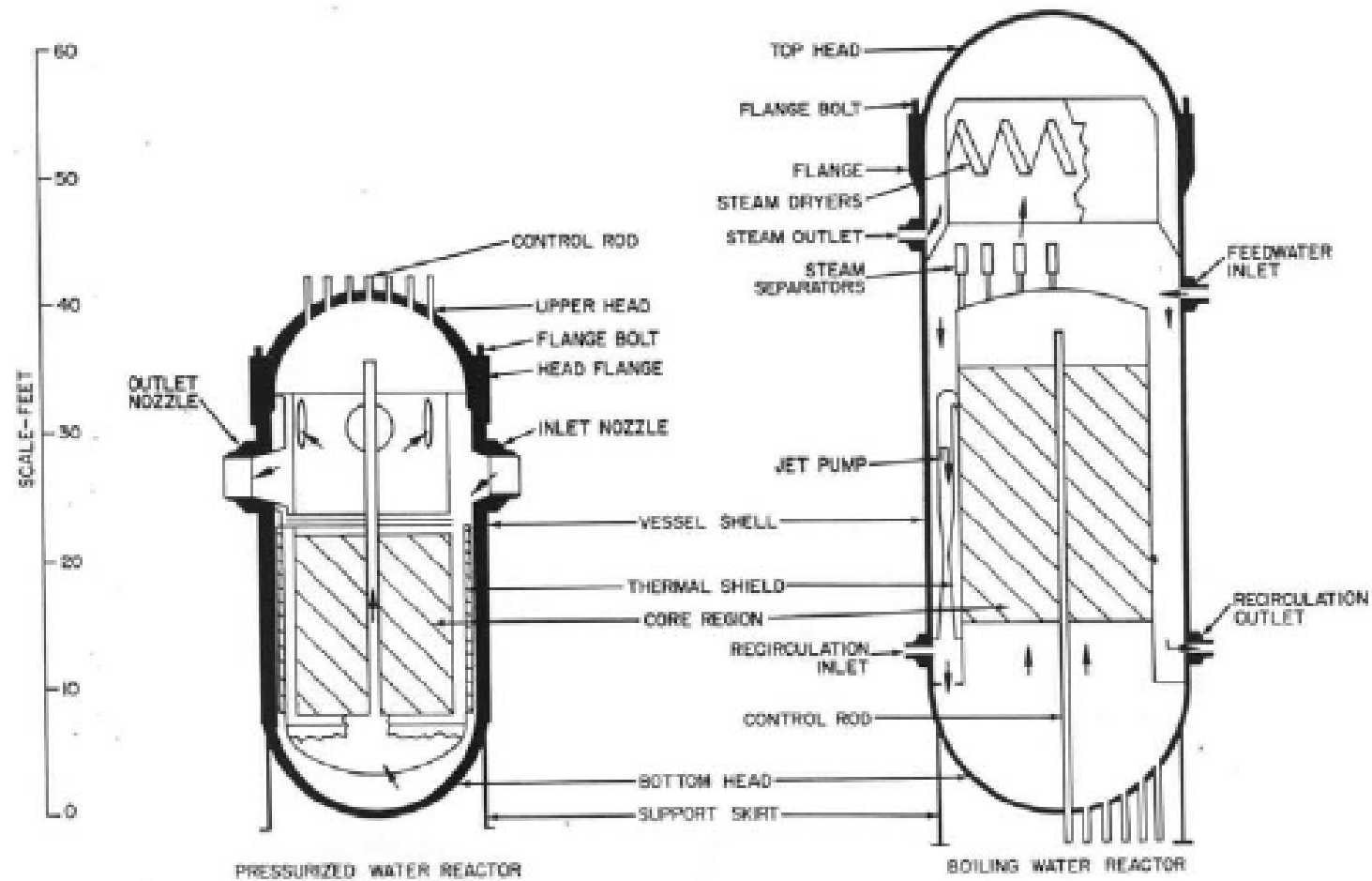

FIG. 6. Comparison of PWR and BWR RPVs with the same output.

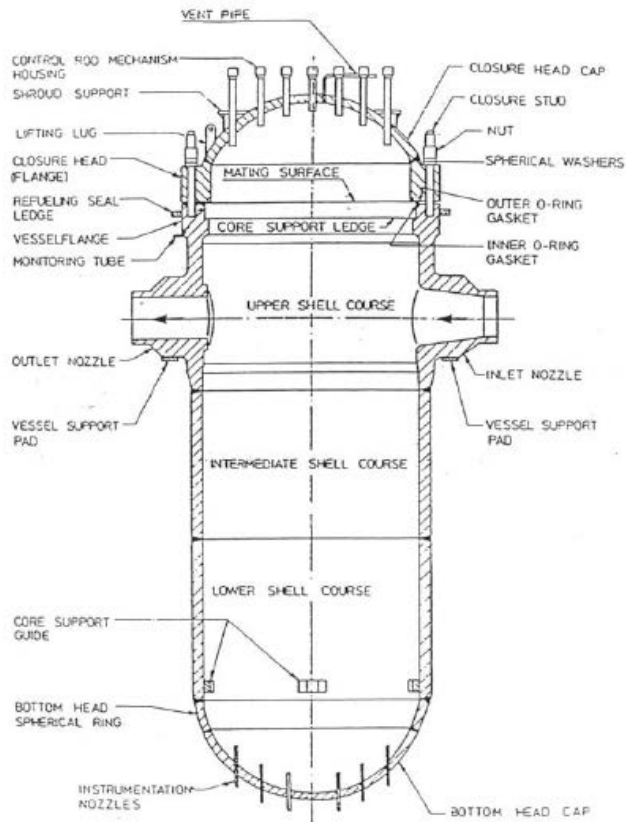

FIG. 2. Typical Westinghouse RPV.

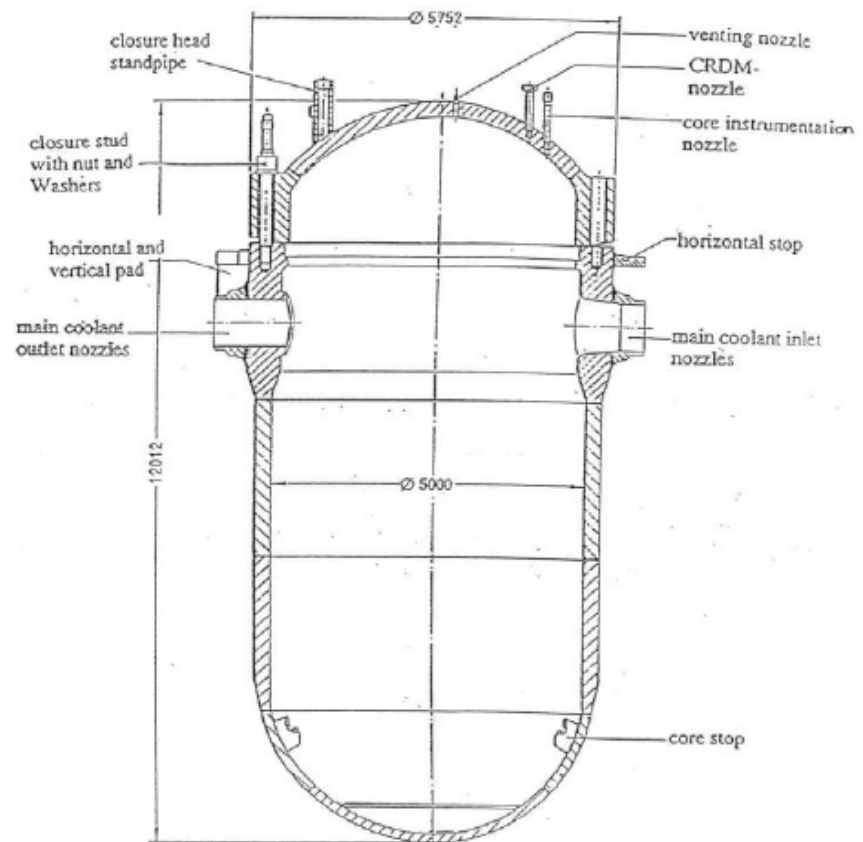

FIG. 4. A typical Siemens/KWU RPV for a 1300 MWe plant.



## TYPICAL PWR RPV



▶ Vessels may weigh up to 800t with wall thickness up to ~330mm.

## WWER-440 RPV



## . OPERATING LIFETIME FLUENCE FOR WWERs, PWRs AND THE BWR

REACTOR TYPE	FLUX, $n.m^{-2}.sec^{-1}$ ( $E > 1MeV$ )	LIFETIME* FLUENCE, $n.m^{-2}$ ( $E > 1MeV$ )
WWER-440 core weld	$1.2 \times 10^{15}$	$1.1 \times 10^{24}$
WWER-440 maximum	$1.5 \times 10^{15}$	$1.6 \times 10^{24}$
WWER-1000	$3-4 \times 10^{14}$	$3.7 \times 10^{23}$
PWR (W)	$4 \times 10^{14}$	$4 \times 10^{23}$
PWR (B&W)	$1.2 \times 10^{14}$	$1.2 \times 10^{23}$
BWR	$4 \times 10^{13}$	$4 \times 10^{22}$





## Design neutron fluence as a function of water gaps/ neutron reflector thickness

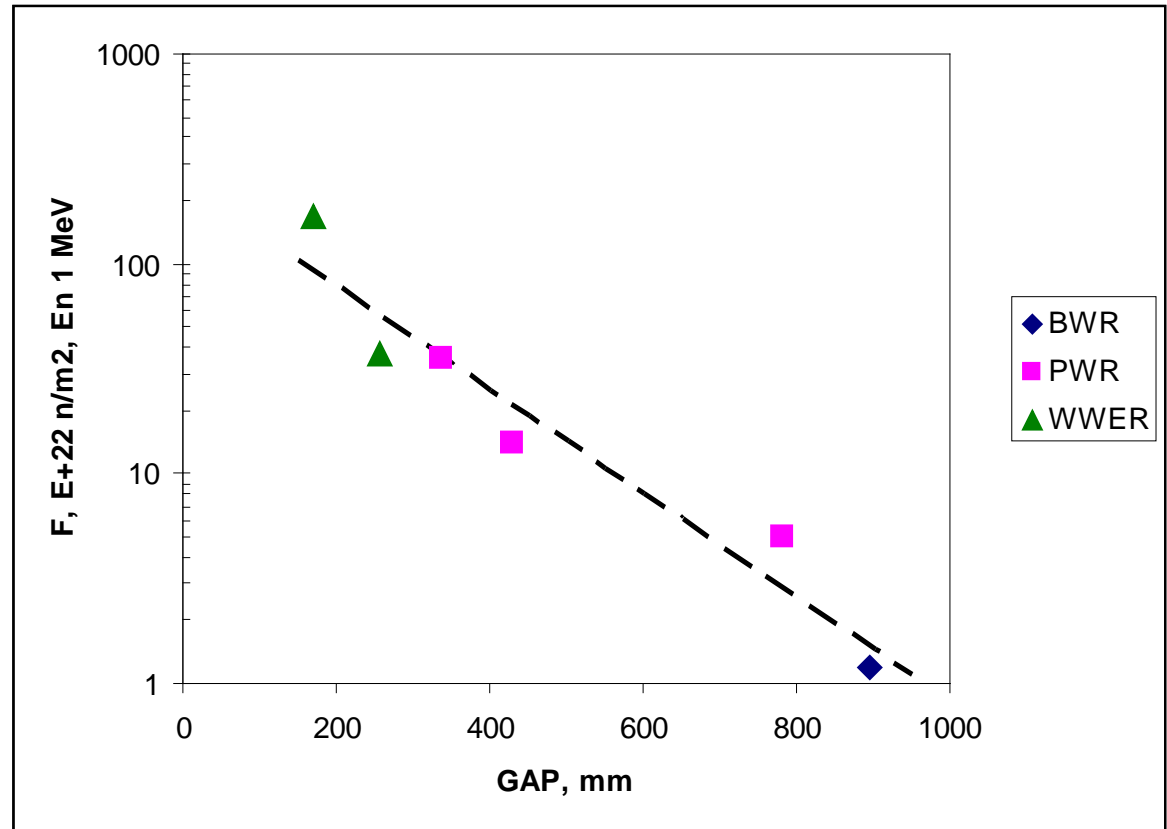
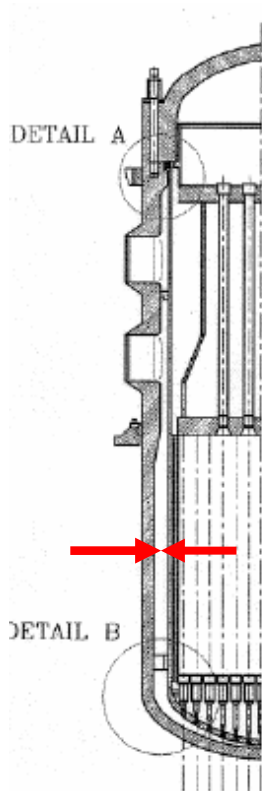

# RPV MATERIALS



- ❑ **ONLY MATERIALS THAT ARE DEFINED IN CODES CAN BE USED FOR MANUFACTURING OF RPVs**
- ❑ **USE OF A NEW MATERIAL AND/OR MODIFICATION MUST BE SUPPLIED BY A WIDE PROGRAMME OF TESTING (MATERIAL QUALIFICATION PROGRAMME) AND APPROVED BY APPROPRIATE INSTITUTION**
- ❑ **DIFFERENT TYPE OF MATERIALS ARE USED FOR WESTERN PWR/BWR AND WWER**



Material specification	Used from	Steel type	Heat treatment	Rp 0,2/RT (minimum MPa)	Rm/RT (MPa)	A5/RT (minimum %)
<b>PLATES</b>						
A 212B	1955	C-Mn	HR or N	262	483-586	22
A 302B	1960	Mn-Mo	Q/T or N/T	345	552-689	20
A 302B (modified)	1965	Mn-Mo-Ni	Q/T	345	552-689	20
A 533 Gr.B Class 1	1967	Mn-Mo-Ni	Q/T	345	620-793	18
20MnMoNi55	1974	Mn-Mo-Ni	Q/T	440	590-740	18
15Kh2MFA	1960	Cr-Mo-V	Q/T	431	539-735	14
<b>FORGINGS</b>						
A 105	1955	C-Mn	A or N	248	483 min.	22
A 182	1956	Mn-Mo	A or N/T	276	483 min.	22
A 350-82	1956	Mn-Ni	A or N/T	207	414 min.	22
A 336 (modified)	1965	Mn-Mo-Ni	Q/T	345	550 min.	20



A 508 Class 2	1961	Mn-Mo-Ni	Q/T	345	550-725	18
A 508 Class 3	1965	Mn-Mo-Ni	Q/T	345	550-725	18
20MnMoNi55	1974	Mn-Mo-Ni	Q/T	440	590-740	18
22NiMoCr37	1980	Mn-Mo-Ni	Q/T	440	590-740	18
16 MN D5	1978	Mn-Mo-Ni	Q/T			
15Kh2MFA	1960	Cr-Mo-V	Q/T	431	539-735	14
15Lh2NMFA(A)	1975	Cr-Ni-Mo-V	Q/T	490	608	15
15Kh2NMFA Class 1	2000	Cr-Ni-Mo-V	Q/T	490	608	15
15Ch2V2FA	2005	Cr-V	Q/T	490	608	15
15Kh2MFA-A mod.A	2009	Cr-Mo-V	Q/T	490	608	15

**HR = hot rolled, A = annealed, N = normalized,**

**N/T = normalized and tempered, Q/T = quenched  
and tempered**



# RPV MATERIALS



Designation	Elements (mass %)													
	C	Si	Mn	P	S	Cr	Mo	Ni	V	Cu	Al	Sn	N	As
ASTM A 302B	max	0.15	1.15	max	max		0.45							
	0.25	0.30	1.50	0.035	0.040		0.60							
ASTM A 336, Code Case 1236	0.19	0.15	1.10	max	max	max	0.50	0.40						
	0.25	0.35	1.30	0.035	0.035	0.35	0.60	0.50						
ASME A 508 Cl 2 (1971)	max	0.15	0.50	max	max	0.25	0.55	0.50	max					
	0.27	0.35	0.90	0.025	0.025	0.45	0.70	0.90	0.05					
ASME A 533 GR B (1971)	max	0.15	1.15	max	max		0.45	0.40						
	0.25	0.30	1.50	0.035	0.040		0.60	0.70						
ASME A 508 Cl 2 (1989) <sup>a</sup>	max	0.15	0.50	max	max	0.25	0.55	0.50	max	max				
	0.27	0.40	1.00	0.015	0.015	0.45	0.70	1.00	0.05	0.15				
ASME A 508 Cl 3 (1989) <sup>a</sup>	max	0.15	1.20	max	max	max	0.45	0.40	max					
	0.25	0.40	1.50	0.015	0.015	0.25	0.60	1.00	0.05					
ASME A 533Gr B (1989)	max	0.15	1.15	max	max		0.45	0.40						
	0.25	0.40	1.50	0.035	0.040		0.60	0.70						
16 MnD5 RCC-M 2111 <sup>b</sup>	max	0.10	1.15	max	max	max	0.43	0.50	max	max	max			
	0.22	0.30	1.60	0.02	0.012	0.25	0.57	0.80	0.01	0.20	0.040			
18 MnD5 RCC-M 2112 (1988)	max	0.10	1.15	max	max	max	0.45	0.50	max	max	max			
	0.20	0.30	1.55	0.015	0.012	0.25	0.55	0.80	0.01	0.20	0.040			
20 Mn Mo Ni 5 5 (1983, 1990) <sup>c,d</sup>	0.17	0.15	1.20	max	max	max	0.40	0.50	max	max	0.010	max	max	max
	0.23	0.30	1.50	0.012	0.008	0.20	0.55	0.80	0.02	0.12 <sup>e</sup>	0.040	0.011	0.013	0.036
22 Ni Mo Cr 3 7 (1991) <sup>f</sup>	0.17	0.15	0.50	max	max	0.25	max	0.60	max	max	0.010	max	max	max
	0.23	0.35	1.00	0.012	0.008	0.50	0.60	1.20 <sup>g</sup>	0.02	0.12 <sup>e</sup>	0.050	0.011	0.013	0.036

<sup>a</sup> Supplementary Requirement S 9.1(2) and S 9.2 for A 508 Cl 2 and A508 Cl 3.

<sup>b</sup> Forgings for reactor shells outside core region. Restrictions for core region (RCC-M 2111): S ≤ 0.008, P ≤ 0.008, Cu ≤ 0.08.

<sup>c</sup> VdTÜV Material Specification 401, Issue 1983.

<sup>d</sup> KTA 3201.1 Appendix A, Issue 1990.

<sup>e</sup> Cu-Content for RPV (core region) shall be ≤ 0.10%.

<sup>f</sup> According to Siemens/KWU under consideration of SR 10 (MPA Stuttgart).

<sup>g</sup> For flanges and tube sheets the Ni content shall be ≤ 1.40%.



Ocel	Země	C	Mn	Si	P	S	Cr	Ni	Mo	V
A-508 Gr.3Cl.1	USA	0,15- 0,25	1,20- 1,50	0,15- 0,35	max. 0,025	max. 0,025	max. 0,25	0,40- 1,00	0,45- 0,60	max. 0,05
16 MND 5	Francie	0,16	1,38	0,24	0,005	0,008	0,17	0,70	0,50	0,005
22MnMoNi55	Německo	0,17- 0,23	1,20- 1,50	0,15- 0,30	max. 0,015	max. 0,015	max. 0,02	0,45- 0,80	0,45- 0,60	max. 0,02
15Ch2MFA	Rusko	0,13- 0,18	0,30- 0,60	0,17- 0,37	max. 0,025	max. 0,025	2,50- 3,00	max. 0,40	0,60- 0,80	0,25- 0,35
15Ch2NMFA	Rusko	0,13- 0,18	0,30- 0,60	0,17- 0,37	max. 0,020	max. 0,020	1,80- 2,30	1,00- 1,50	0,50- 0,70	max. 0,10



## REACTOR PRESSURE VESSELS-4

GUARANTEED MECHANICAL PROPERTIES OF LWR RPV MATERIALS\*

MATERIAL	20 °C				350 °C				T <sub>10</sub> <sup>(1)</sup> RT <sub>NDT</sub> <sup>(2)</sup>
	R <sub>p0.2</sub>	R <sub>m</sub>	A <sub>5</sub>	Z	R <sub>p0.2</sub>	R <sub>m</sub>	A <sub>5</sub>	Z	
	[MPa]	[MPa]	[%]	[%]	[MPa]	[MPa]	[%]	[%]	[°C]
15Kh2MFA - base metal	431	519	14	50	392	490	14	50	0 <sup>(1)</sup>
- A/S weld metal	392	539	14	50	373	490	12	45	20 <sup>(1)</sup>
15Kh2NMFA - base metal	490	608	15	55	441	539	14	50	-10 <sup>(1)</sup>
15Kh2NMFA.A - base metal	490	608	15	55	441	539	14	50	-25 <sup>(1)</sup>
- A/S weld metal	422	539	15	55	392	510	14	50	0 <sup>(1)</sup>
A 533-B, CL1	345	551	18	-	285	-	-	-	-12 <sup>(2)</sup>
A 508, CL3	345	551	18	38	285	-	-	-	-12 <sup>(2)</sup>





## REQUIREMENTS FOR BELTLINE RPV MATERIALS

MATERIAL	P	S	Cu	As	Sb	Sn	P+Sb+Sn	Co
<b>GENERATION II</b>								
15Kh2MFAA	0.012	0.015	0.08	0.010	0.005	0.005	0.015	0.020
15Kh2NMFAA	0.010	0.012	0.08	0.010	0.005	0.005	0.015	0.020
A 533-B, Class 1	0.012	0.015	0.10					
16 MnD 5	0.008	0.008	0.08					
20 MnMoNi 55	0.012	0.012	0.10	0.036		0.011		
<b>GENERATION III</b>								
SA-508 Grade 3 Class 1 SA 533-B	0.010	0.010	<b>0.03</b>					
16 MnD 5	0.008	0.008	0.08					
15Kh2NMFAA	0.010	0.012	0.08	0.010	0.005	0.005	0.015	

Element contents in mass %



- **RADIATION DAMAGE VALUE DEPENDS ON:**
  - **NEUTRON FLUENCE (DEPENDS ON REACTOR OUTPUT AND WATER MODERATOR THICKNESS)**
    - **THRESHOLD VALUES**
      - **0,5 MeV FOR VVER REACTORS**
      - **1 MeV FOR PWR REACTORS**
  - **IRRADIATION RATE, i.e. NEUTRON FLUX (FLUX RATE EFFECT)**
  - **IRRADIATION TEMPERATURE**
  - **STEEL TYPE - CARBON STEEL, LOW-ALLOY STEEL, MARAGING..**
  - **CONTENT OF IMPURITIES – P, Cu, ....., As, Sb, Sn,...**
  - **CONTENT OF ALLOYING ELEMENTS – Ni, Mn, ...**
- **More information -**
- **Irradiation effects on RPV: microstructure & mechanical properties**  
L. Malerba



## ❑ RPV – 1st generation:

- **mostly welds with high content of Cu, P**
- **Western PWR**
  - **High content of Cu from weld wire coatings (up to 0.40 mass %, nonhomogenous distribution)**
  - **Medium/low content of P**
- **WWER**
  - **High content of P from welding flux (up to 0.045 %)**
  - **medium/low content of Cu)**



## Trend of decrease of important impurities in RPV steels

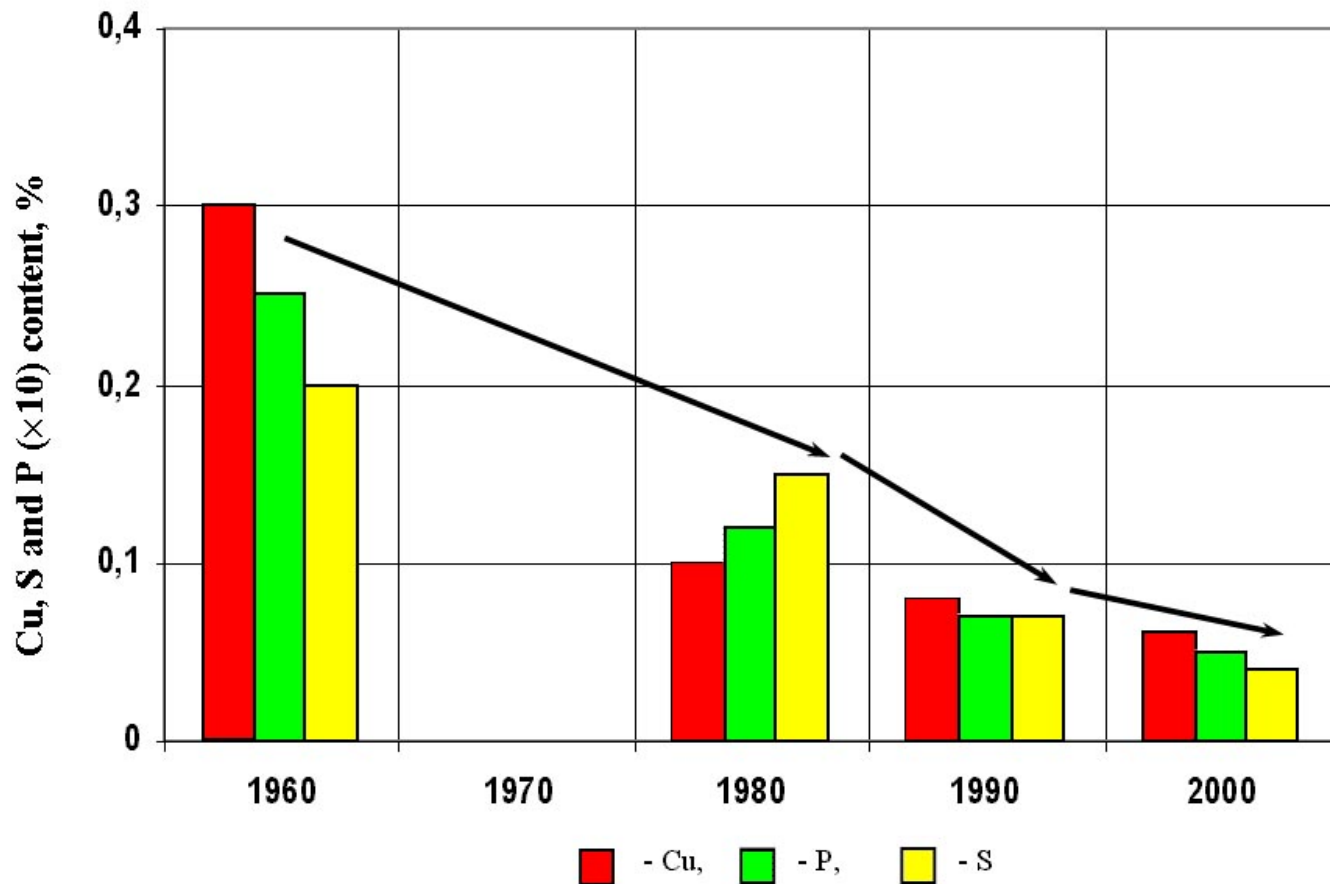

# RPV MANUFACTURING TECHNOLOGY



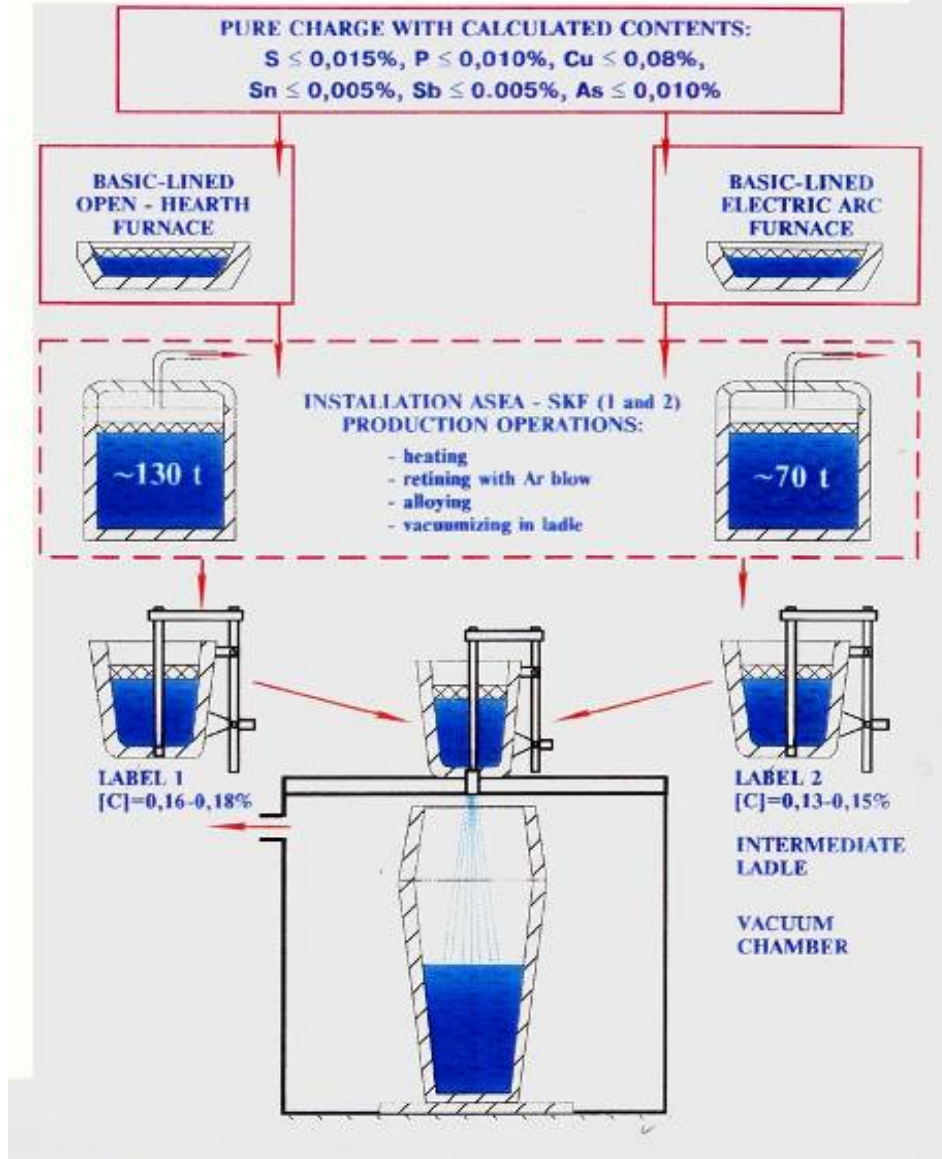



# RPV MANUFACTURING TECHNOLOGY



# RPV MANUFACTURING TECHNOLOGY

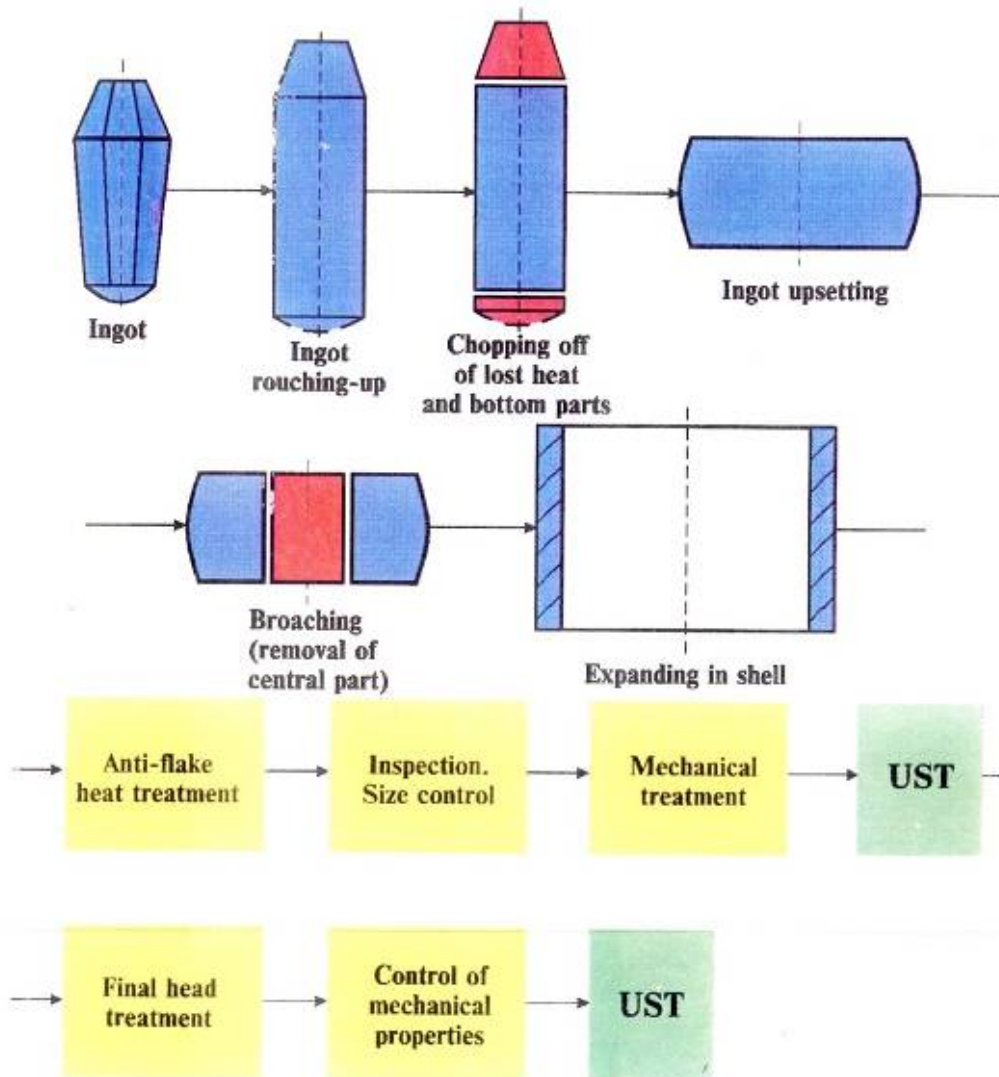



# RPV MANUFACTURING TECHNOLOGY

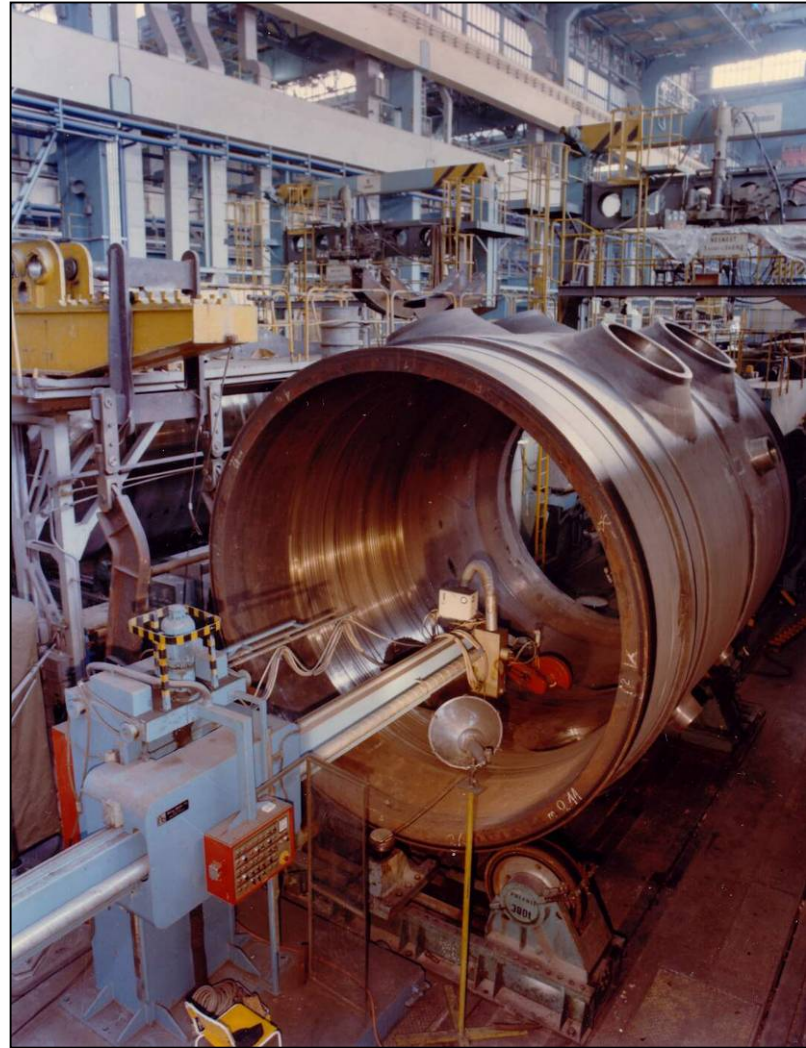

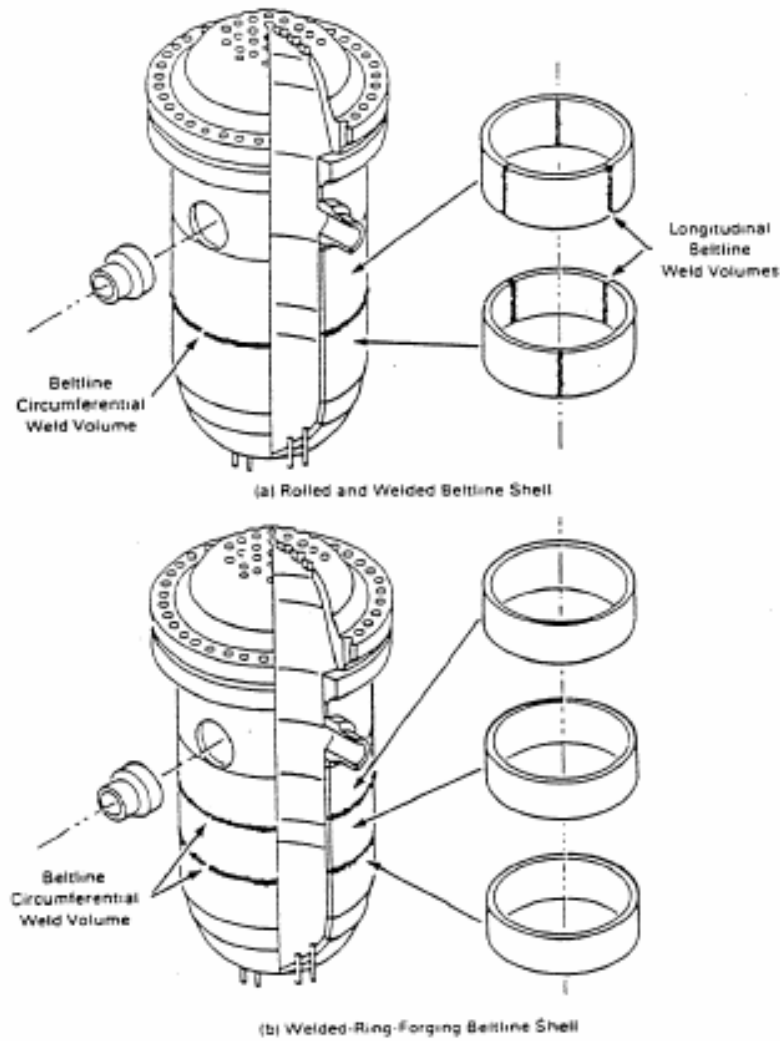
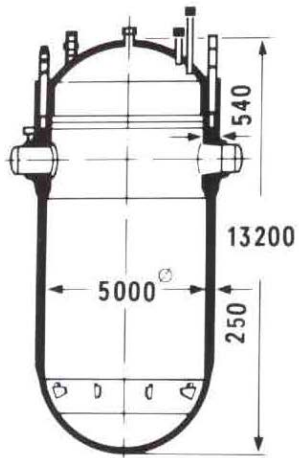

Fig. 9. Fabrication configuration of PWR beltline shells.



## RPV design developments



- ❑ removal of axial welds
- ❑ decrease of number of circumferential welds (ISI, lowering of cost)
- ❑ removal of welds in beltline region

# RPV MATERIAL PROPERTIES





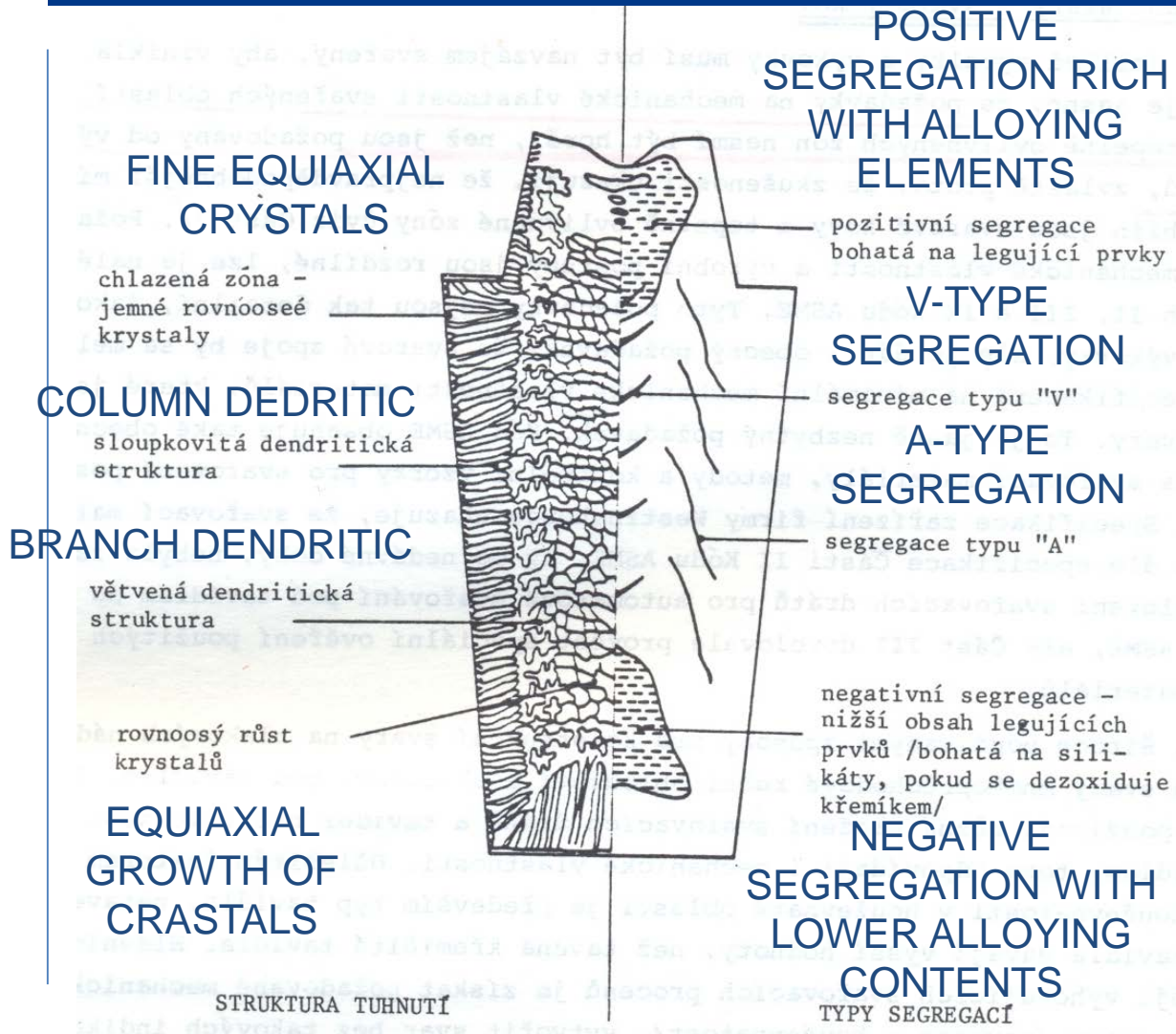

SOLIFICATION

SEGREGATIONS



## RESULTING CARBON SEGREGATION IN 400 T FORGING

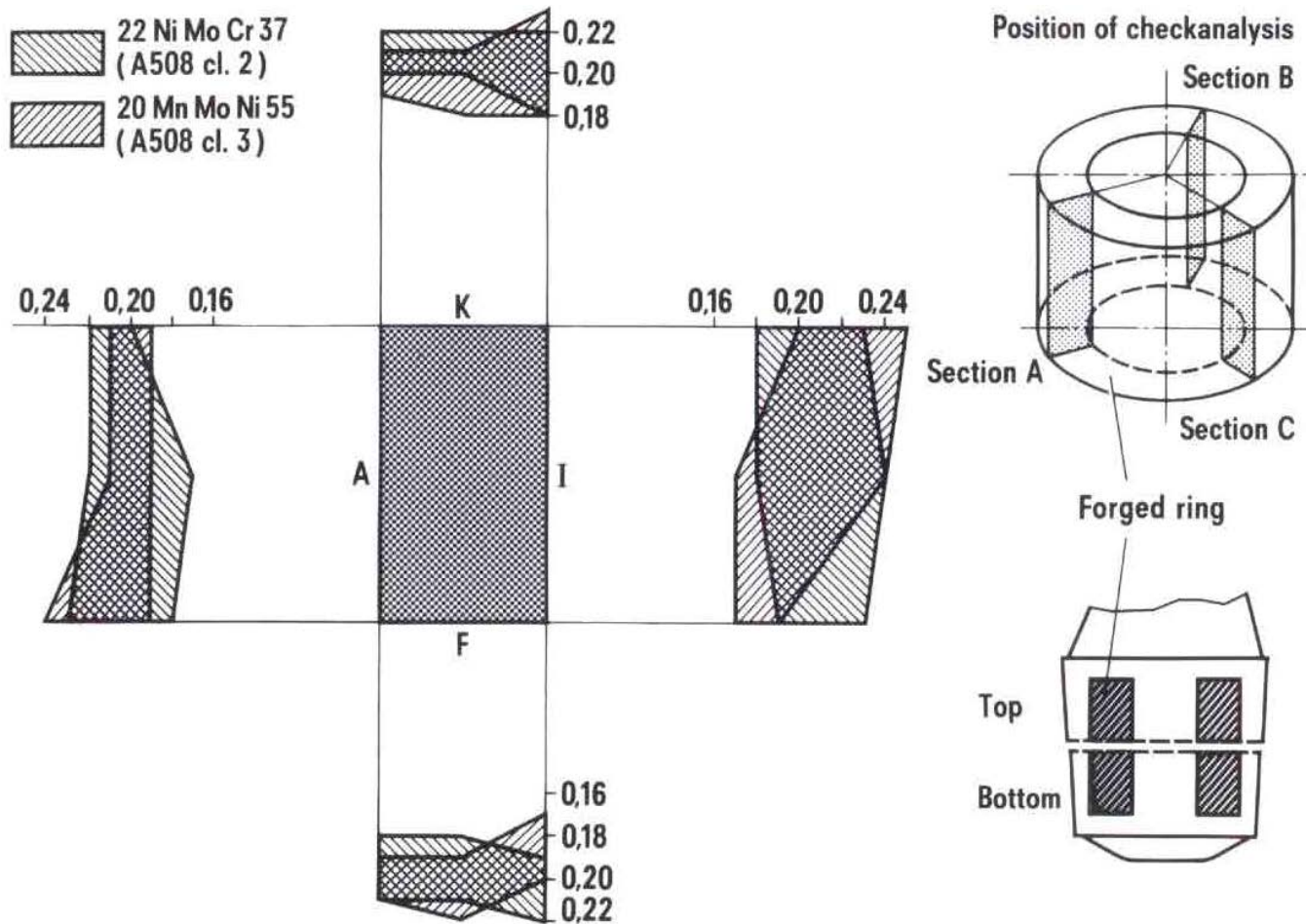

## TYPICAL DISTRIBUTION OF ELEMENTS IN FAMILY OF FORGINGS

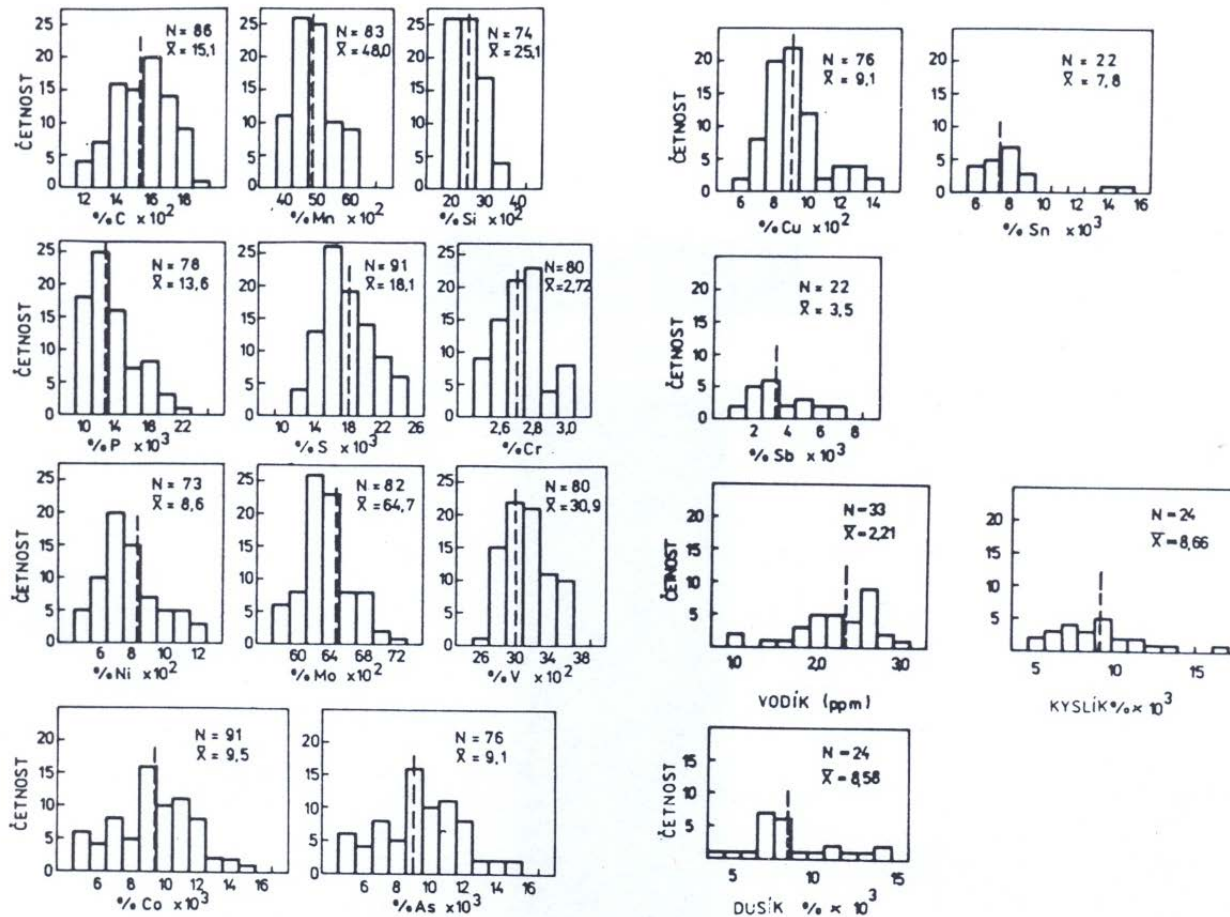

## TYPICAL DISTRIBUTION OF MECHANICAL PROPERTIES IN FAMILY OF FORGINGS

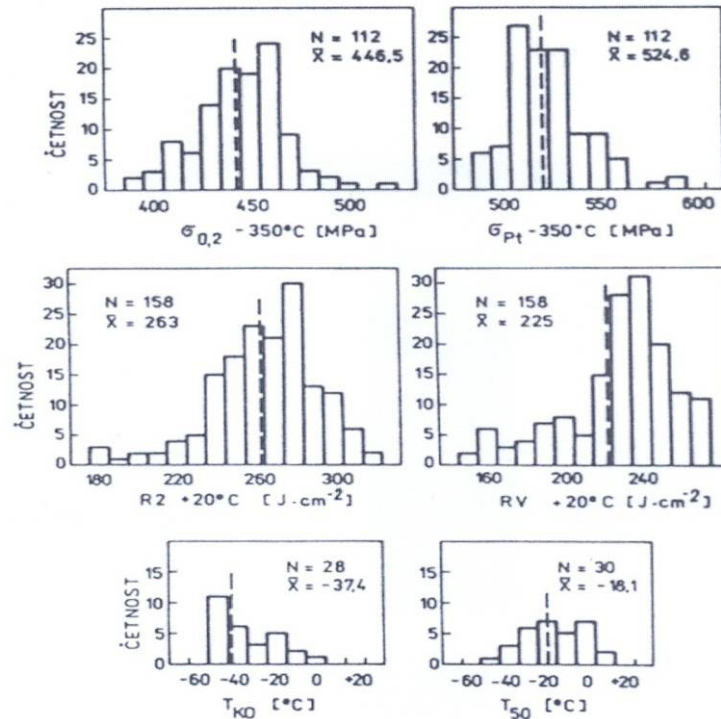



- ❑ **MECHANICAL PROPERTIES OF RPV ELEMENTS ARE DETERMINED FOR SPECIMENS CUT FROM  $\frac{1}{4}$  OF RPV WALL THICKNESS**
- ❑ **DUE TO A LARGE MASS AND VOLUME OF INGOTS THERE IS A LARGE SCATER/DISTRIBUTION OF CHEMICAL COMPOSITION/MECHANICAL PROPERTIES WITHIN THE COMPONENT BUT ONLY DATA FROM  $\frac{1}{4}$  OF THICKNESS ARE PART OF ACCEPTANCE TESTS**
- ❑ **MECHANICAL PROPERTIES PRIMARILY DEPEND ON CHEMICAL COMPOSITION AND ON MICROSTRUCTURE IN GIVEN LOCATION**
- ❑ **MICROSTRUCTURE PRIMARILY DEPENDS ON CHEMICAL COMPOSITION AND COOLING RATE IN GIVEN LOCATION**



## MICROSTRUCTURE OF 15Kh2MFA STEEL AS A RESULT OF DIFFERENT COOLING RATE DURING QUENCHING

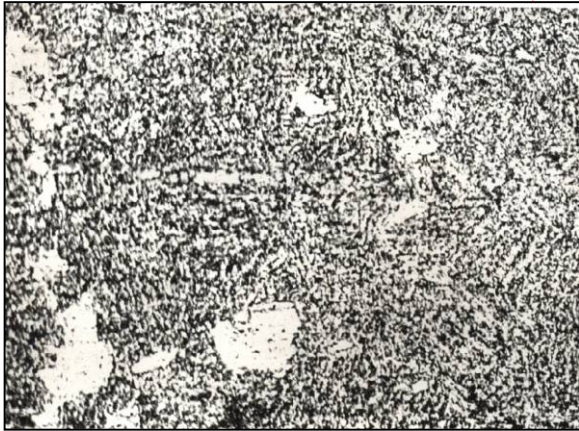

0,04 °C/s (2,4 °C/min)

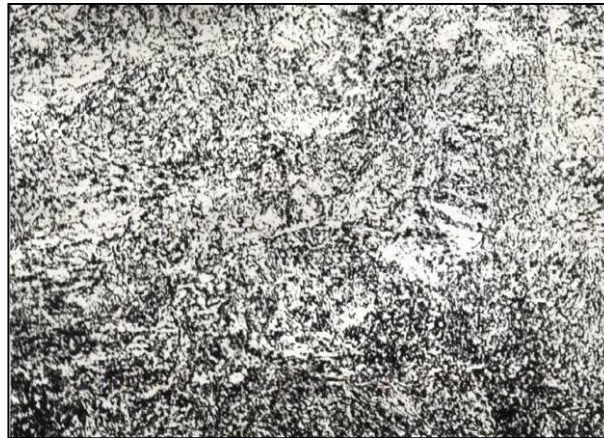

0,15 °C/s (8,0 °C/min)

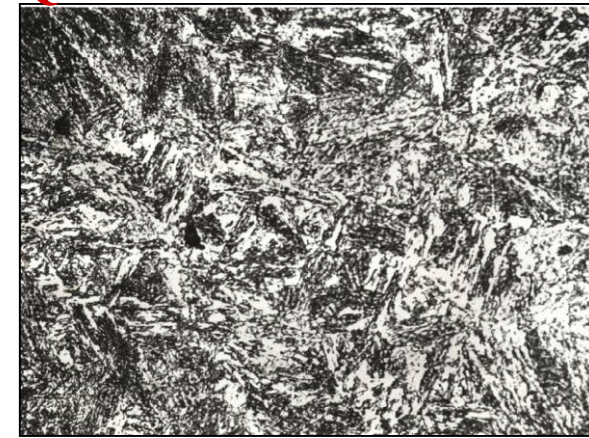

0,30 °C/s (18 °C/min)



1,0 °C/s (60 °C/min)



3,0 °C/s (180 °C/min)



## □ MICROSTRUCTURE OF ASTM A533B/JRQ STEEL THROUGH PLATE THICKNESS (220 mm)

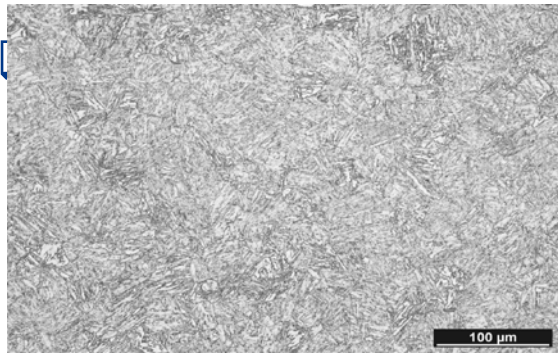

X = 5 MM

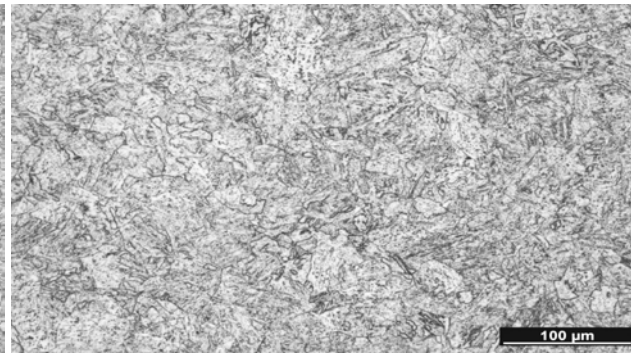

X = 23 MM

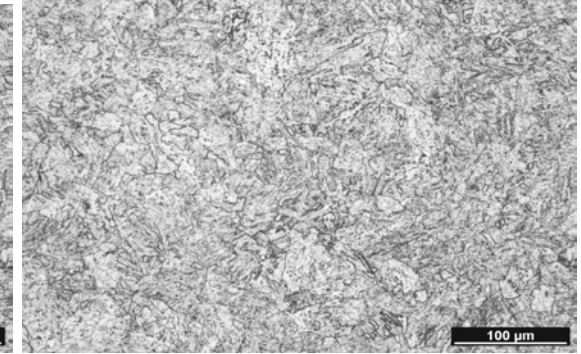

X = 41 M M

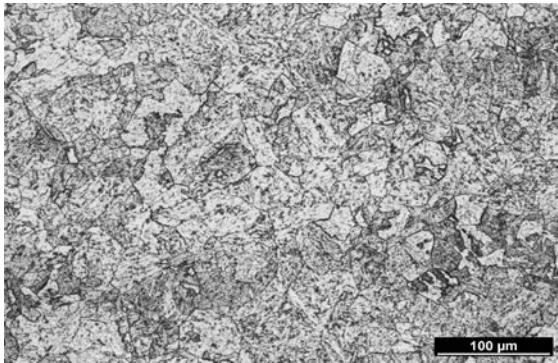

X = 59 MM

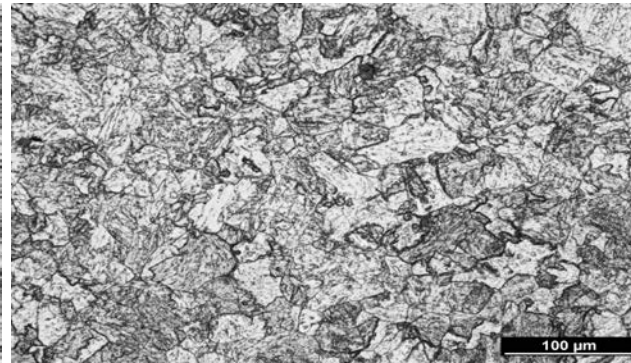

X = 77 MM

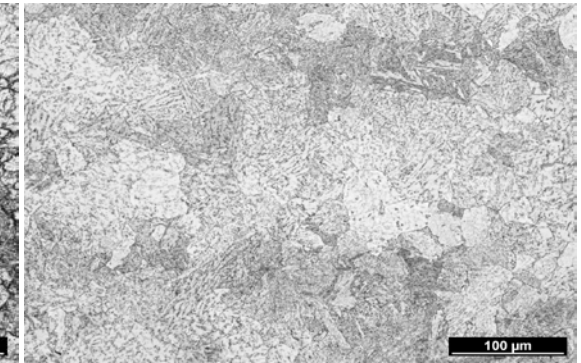

X = 113 MM

## METALLURGICAL CHARACTERISTIC OF FLANGE RING

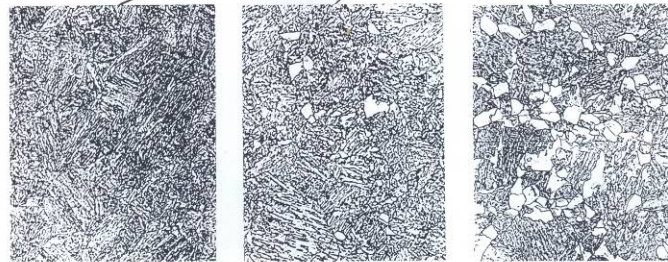
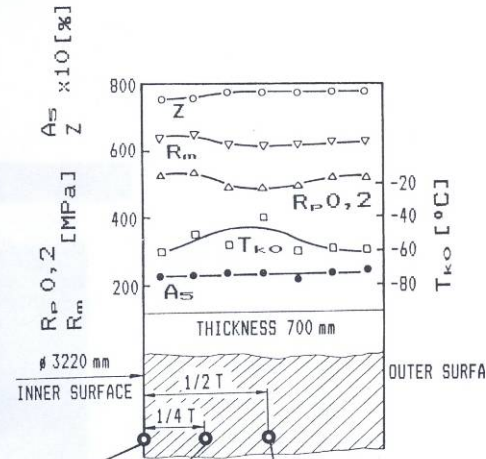

### Product chemical analysis [weight %]

	C	Mn	Si	P	S	Cr	Ni	Mo	V	Co	As	Cu	Sn	Sb
TOP	0,12	0,38	0,27	0,011	0,007	2,22	1,17	0,57	0,09	0,008	0,0045	0,06	0,0045	0,001
BOTTOM	0,12	0,40	0,27	0,009	0,005	2,24	1,18	0,58	0,09	0,009	0,0040	0,06	0,0060	0,001

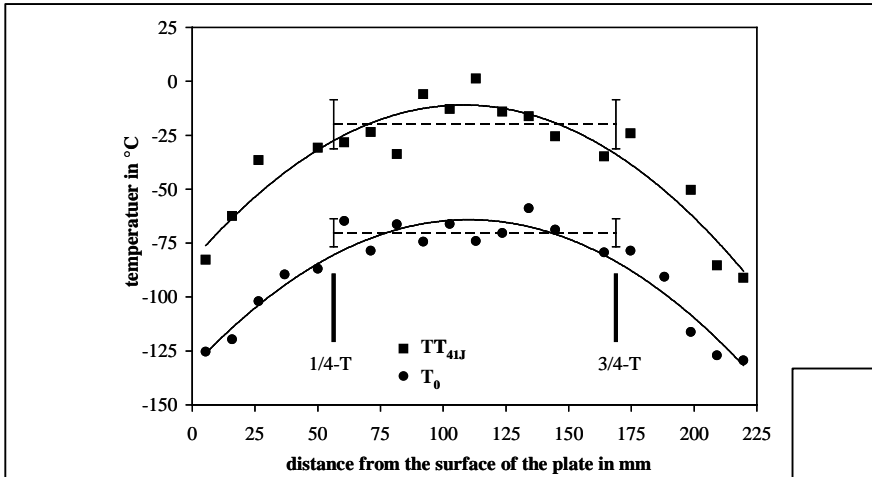
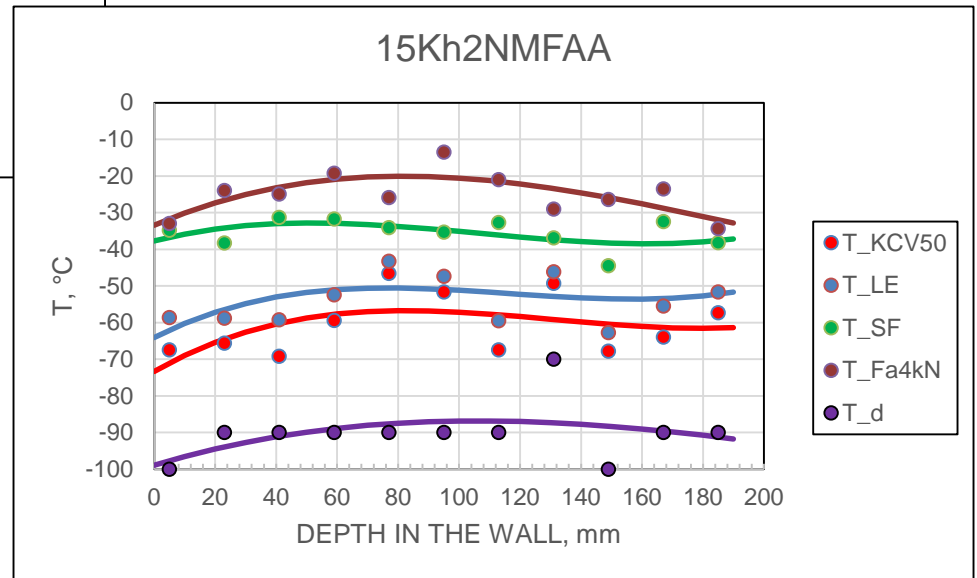

Figure 2. Charpy  $T_{41J}$  and  $T_0$  versus distance from the surface in Block 5JRQ22.



Charpy transition temperatures in 15Kh2NFAA forging



# OPEN ISSUES





- ❑ **QUESTION?**
- ❑ **CAN MODEL ALLOYS WELL REPRESENT RADIATION DAMAGE IN STEELS?**
- ❑ **MODEL ALLOYS ARE USUALLY ONLY FERRITIC ALLOYS WITHOUT CARBON CONTENT**
- ❑ **STEELS ARE COMPOUND OF DIFFERENT PHASES, FERRITIC PART IS MOSTLY VERY SMALL, IF ANY**
- ❑ **THE RESPONSE OF MODEL ALLOYS TO RADIATION IS MOSTLY LARGER THAN IN RPV COMMERCIAL STEELS, BUT MOSTLY SHOWED SOME SIMILITUDE TO THE RESPONSE OF COMMERCIAL STEELS ALLOWING SOME CONFIDENCE IN EXTRAPOLATION**



# OPEN QUESTIONS

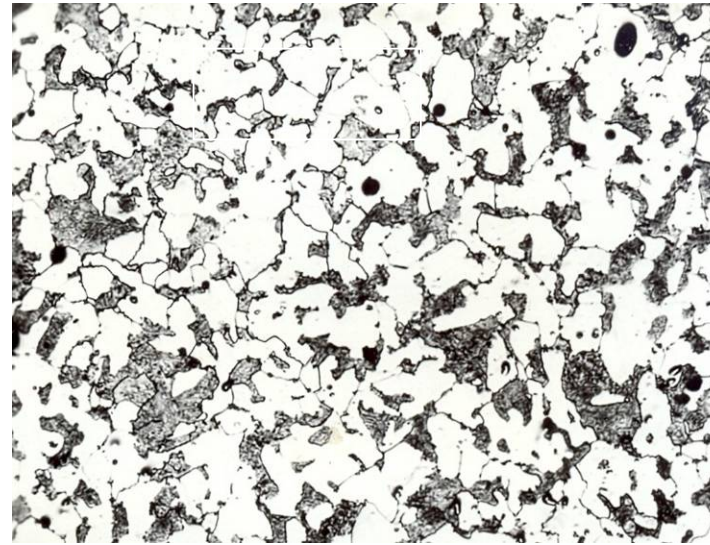
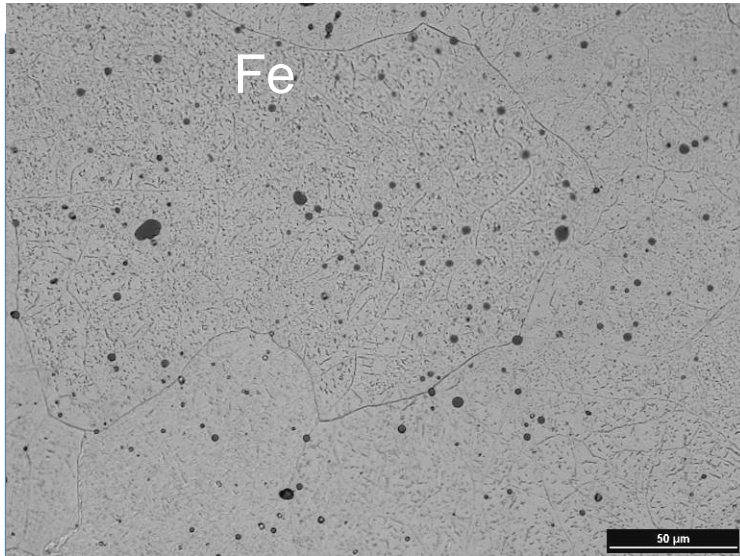

Fe-0.2C

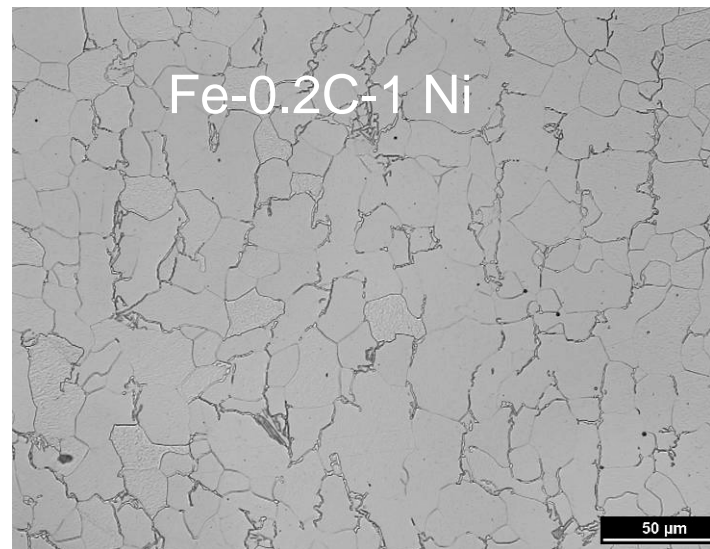
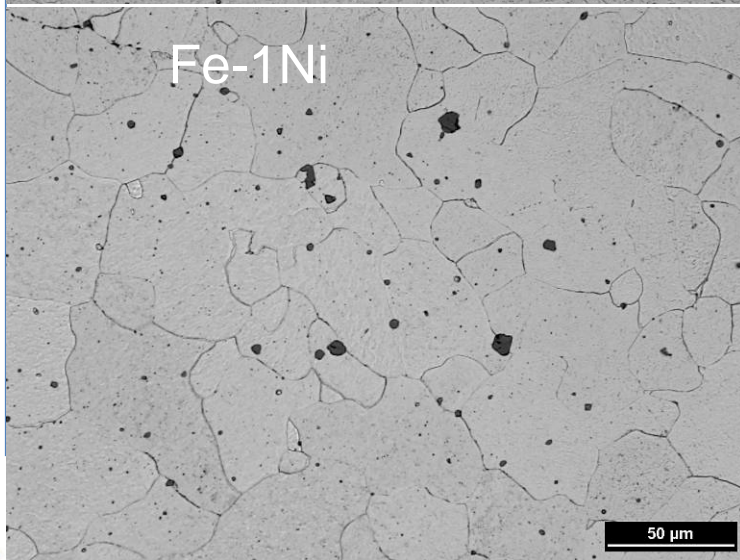



Fe-C-1Cr-1Ni

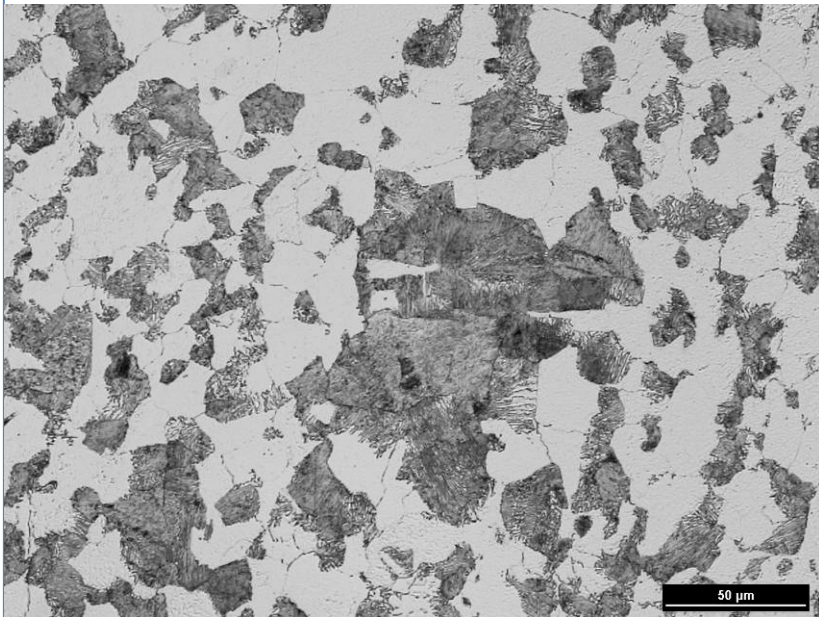

RPV steel

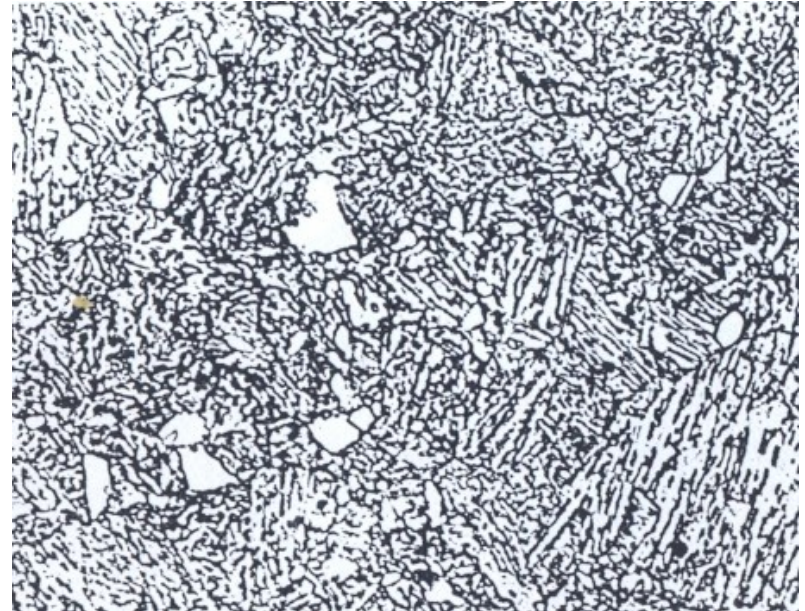

- ❑ **QUESTION?**
- ❑ **DOES RADIATION DAMAGE/EMBRITTELEMENT DEPEND ON STEEL MICROSTRUCTURE?**
- ❑ **DIFFERENT MICROSTRUCTURE EXIST IN DIFFERENT LOCATION OF RPV THICKNESS AND LOCATION**
- ❑ **CHEMICAL COMPOSITION OF PLATES, FORGINGS AND WELDS IS DIFFERENT EVEN FOR ONE TYPE OF RPV MATERIAL, e.g. CONTENT OF CARBON IS SUBSTANTIALLY DIFFERENT IN PLATES/FORGINGS (0.15-0.23 mass %) WHILE ONLY 0.03-0.12 mass % IN WELD METALS**
- ❑ **FORMULAE FOR PREDICTION OF RADIATION EMBRITTELEMENT (SHIFT IN TRANSITION TEMPERATURE) ARE DIFFERENT FOR PLATES/FORGINGS/WELDS WITH THE SAME COMPOSITION OF Cu, P, Ni (Mn, Si)**
- ❑ **THESE FORMULAE ARE ALSO DIFFERENT FOR MATERIALS MANUFACTURED ACCORDING THE SAME STANDARD BUT IN DIFFERENT PLACES**
- ❑ **ONLY RARE TEST RESULTS ARE AVAILABLE**



# OPEN QUESTIONS



Miroslav Vacek<sup>1</sup>

Effect of Various Metallurgical Microstructures on the Response of the Nickel-Molybdenum-Chromium BH 70 Steel to Neutron Irradiation at 285°C

TABLE 1—Chemical composition of the BH 70 steel in percent by weight.

C	Si	Mn	Cr	Mo	Ni	P	S	Ti	V	Cu	Al
0.18	0.25	0.39	0.35	0.39	3.28	0.013	0.014	0.01	0.04	0.15	0.015

TABLE 2—Heat treatment of the BH 70 steel and corresponding Vickers hardness number of bars.

Condition	Heat Treatment	Vickers <sup>a</sup> Hardness, VHN 30
A	920°C, 1 h, water	446
B	920°C, 1 h, water + 650°C, 10 h, water	276
C	920°C, 1 h, salt bath 450°C, 0.5 h, water	294
D	920°C, 1 h, salt bath 450°C, 0.5 h, water + 650°C, 10 h, water	254
E	920°C, 1 h, control cooling in the closed furnace to 630°C <sup>b</sup> + 650°C, 10 h, water	253
F	commercial heat treatment: (870 to 930) °C, water + (600 to 700) °C, 7 h, air	246

<sup>a</sup> Mean value minimally of 15 tests.

<sup>b</sup> From 920°C to 740°C in 1.5 h (120°C/h), to 710°C in 3 h (10°C/h), to 630°C in 1.5 h (53°C/h).

13





# OPEN QUESTIONS



A-Untempered martensite

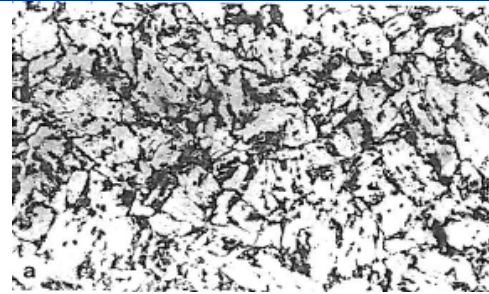

D-Tempered bainite

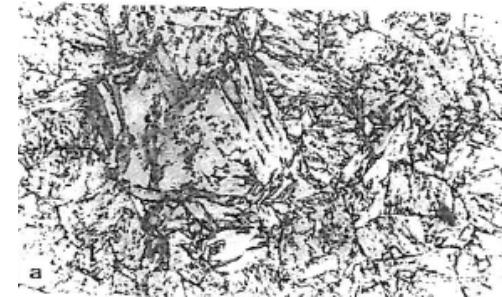

B-Tempered martensite

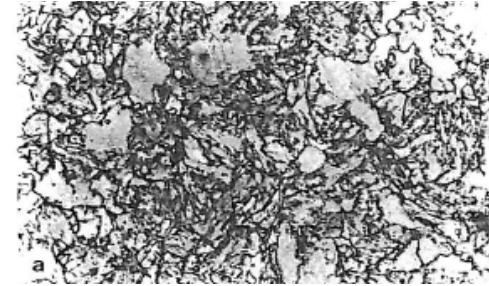

E-ferrite,perlite,bainite, martensite

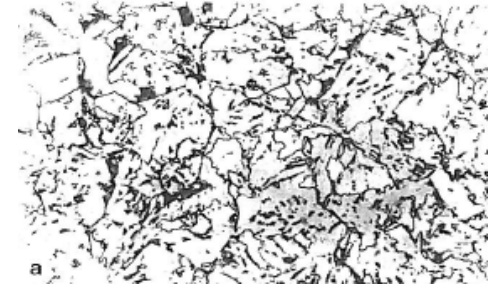

C-Tempered bainite

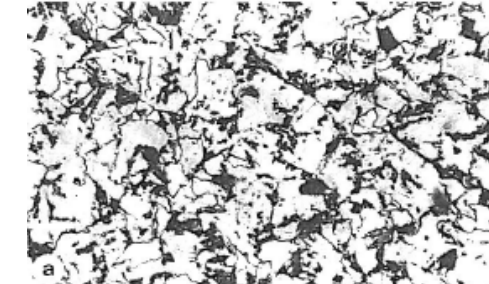

F-tempered martensite, perlite, bainite

- ❑ **QUESTION?**
- ❑ **WHAT IS AN EFFECT OF CARBON IN STEELS DURING IRRADIATION?**
- ❑ **EFFECT OF CARBON IS STILL UNDERESTIMATED/NEGLECTED IN PREDICTING FORMULAE AND MODELS**
- ❑ **EFFECT OF CARBON CAN BE SEEN IN TENSILE STRESS-STRAIN DIAGRAMS – EFFECT OF COTTRELL ATMOSPHERES ON EXISTENCE OF YIELD POINT AND LÜDERS STRAIN**
  - **THIS EFFECT IS DIFFERENT FOR DIFFERENT STEELS AND ALSO MANUFACTURING TECHNOLOGIES**
  - **THIS EFFECT IS ALSO CHANGING DURING IRRADIATION – IN SOME STEELS IS DIMISHING, IN SOME STEELS IS ARRISING**



## STRESS-ELONGATION CURVES FOR 15Kh2MFA TYPE STEEL

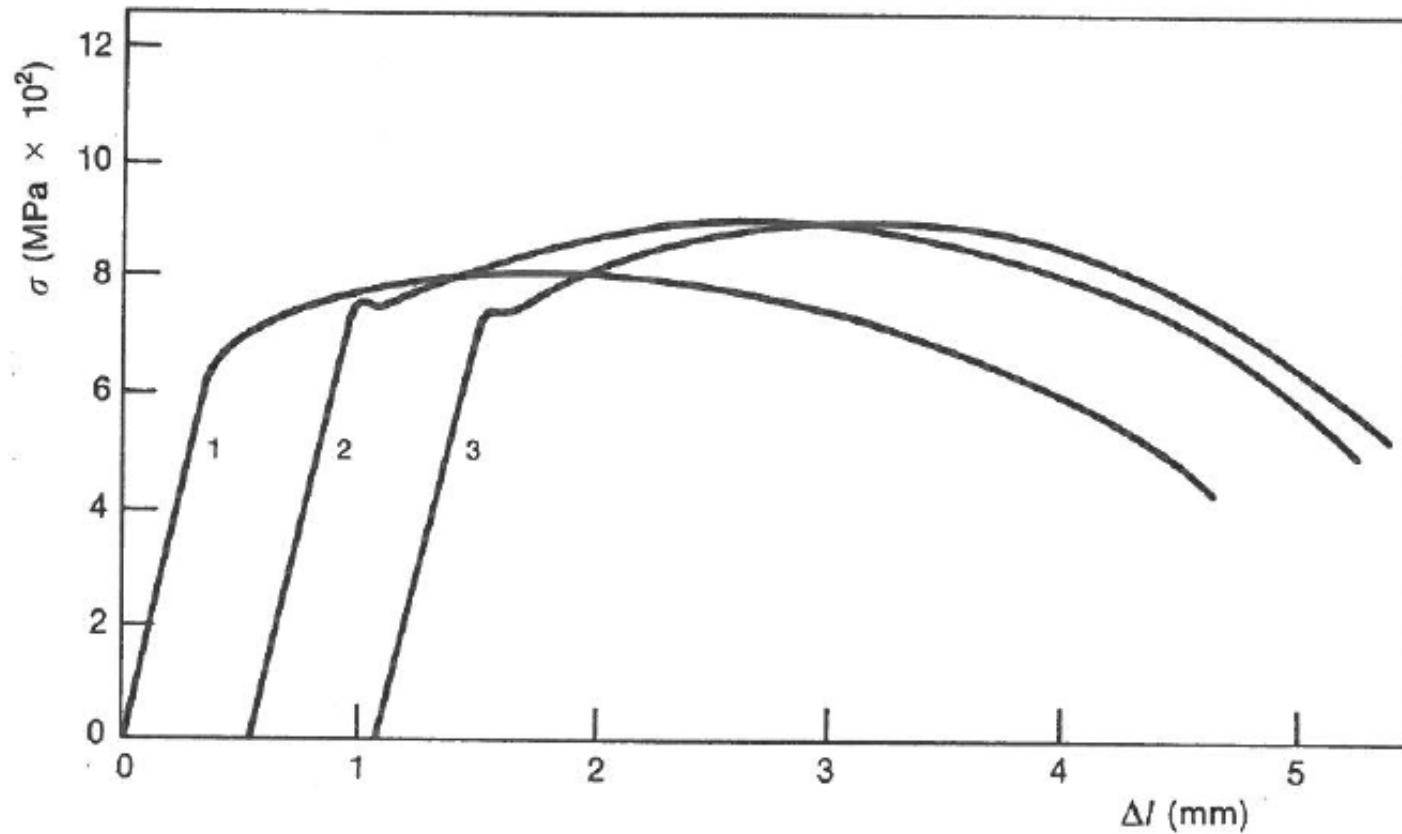

## STRESS-ELONGATION CURVES FOR ASTM A 533-B STEEL

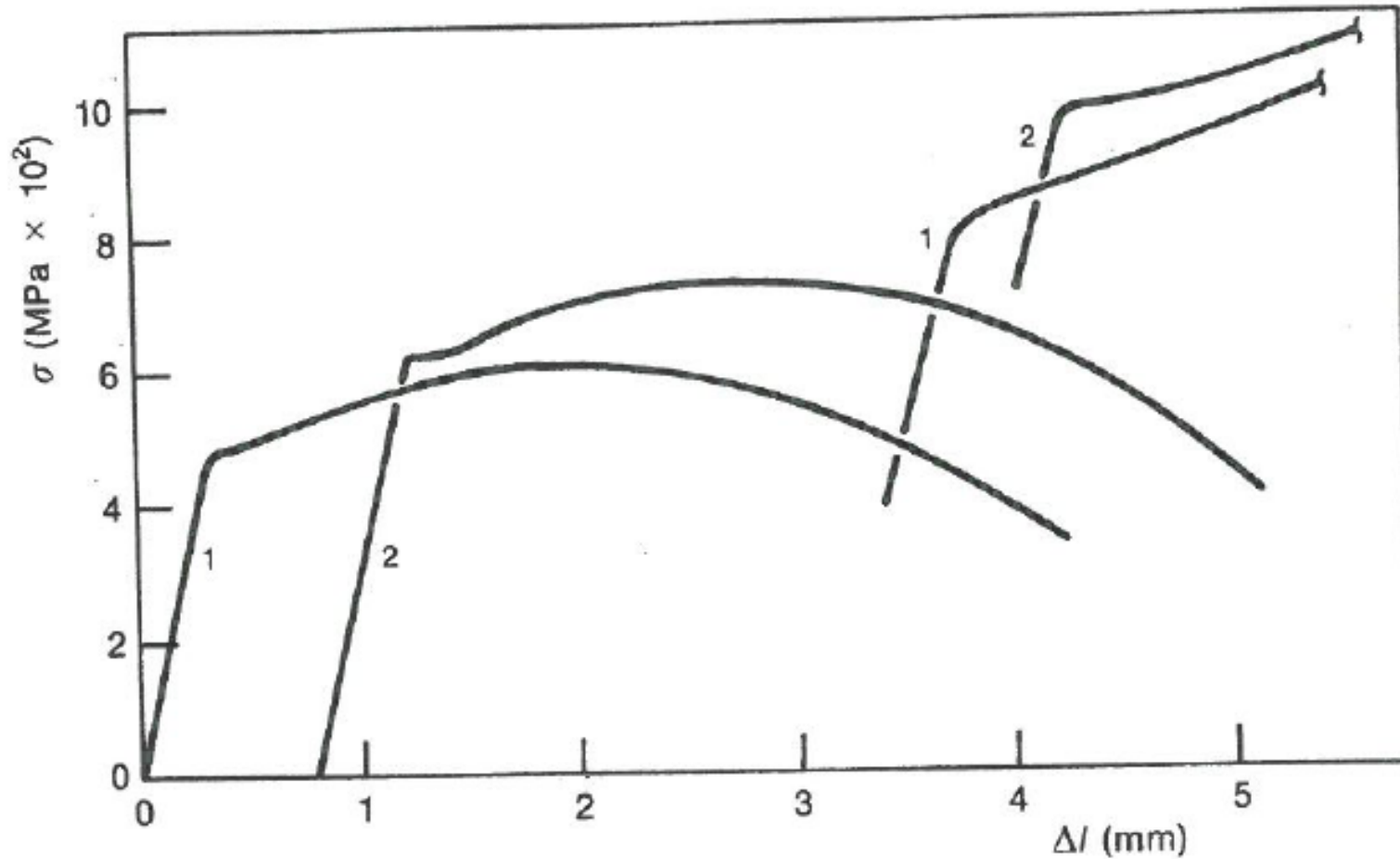

## STRESS-ELONGATION CURVES FOR JAPANESE A 508 Cl.3 FORGING

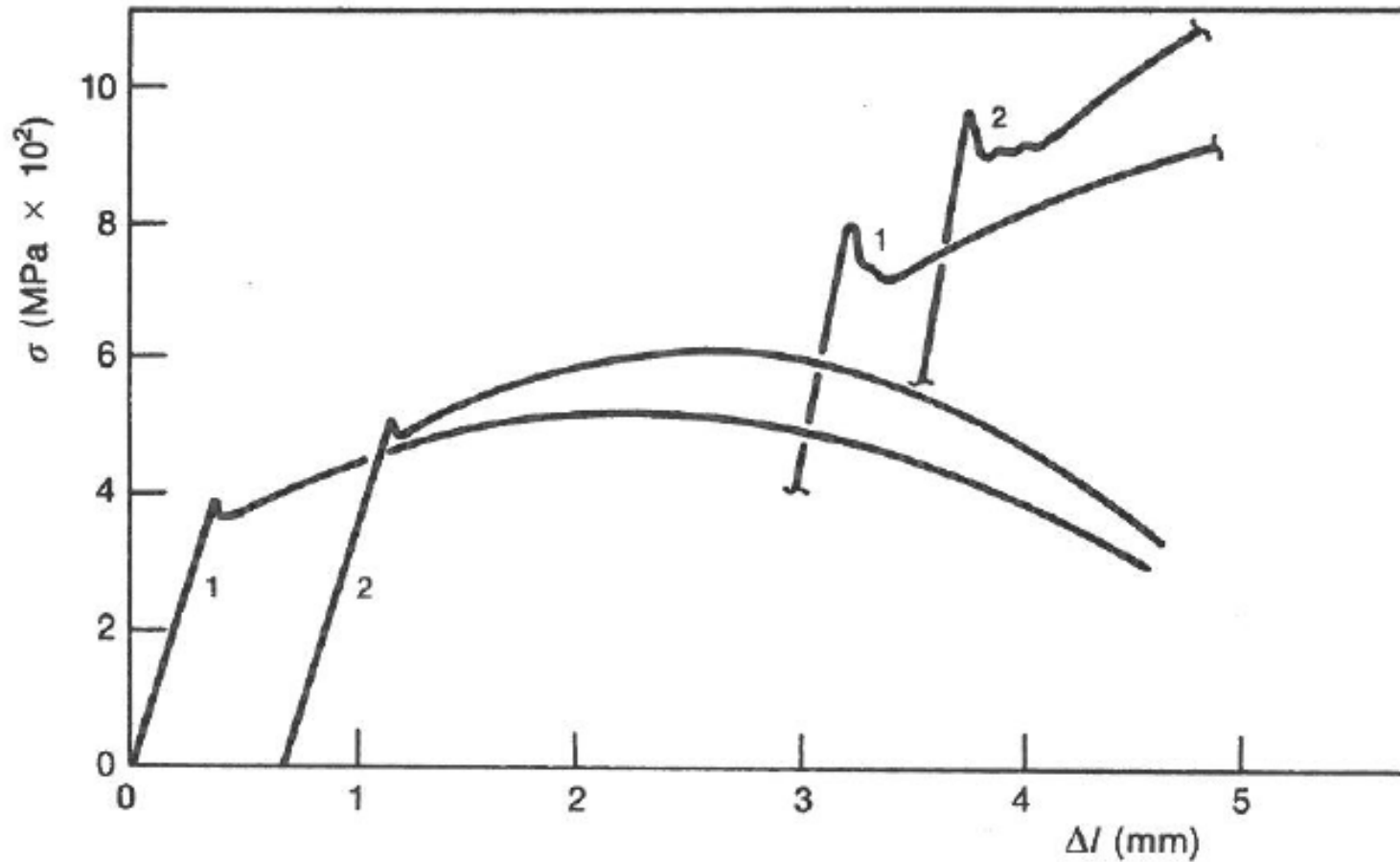



## STRESS-ELONGATION CURVES FOR FRENCH A 508 Cl.3 FORGING

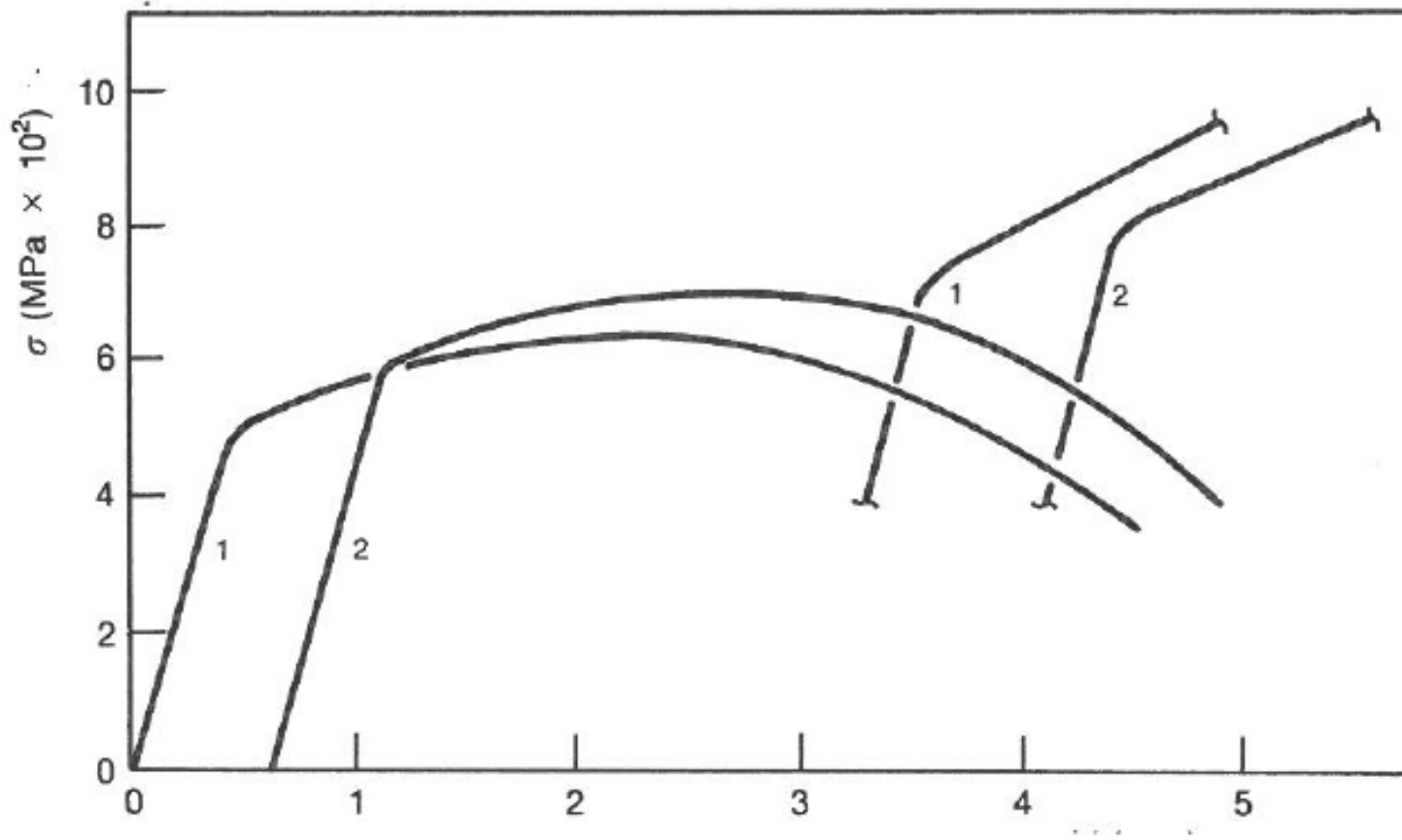

# CONCLUSIONS



- ❑ **FAMILY OF STEELS USED FOR RPV MANUFACTURING IS LIMITED BY CODES AND STANDARDS**
- ❑ **DUE TO LARGE MASS AND VOLUME OF RPV COMPONENTS THERE IS A SCATTER OF CHEMICAL COMPOSITION, MICROSTRUCTURE AND MECHANICAL PROPERTIES WITHIN THESE COMPONENTS**
- ❑ **EFFECT OF MICROSTRUCTURE AND SOME OTHER ELEMENTS (e.g. CARBON) ON RADIATION DAMAGE IS STILL NOT FULLY UNDERSTAND AND INCLUDED IN PREDICTING FORMULAE**



# LITERATURE



IAEA-TECDOC-1556

***Assessment and Management of  
Ageing of Major Nuclear Power Plant  
Components Important to Safety:  
PWR Pressure Vessels  
2007 Update***



June 2007

IAEA-TECDOC-1470

***Assessment and  
management of ageing of major  
nuclear power plant components  
important to safety:  
BWR pressure vessels***



October 2005



## IAEA Nuclear Energy Series

No. NP-T-3.11

Basic  
Principles

Objectives

Guides

Technical  
Reports

### Integrity of Reactor Pressure Vessels in Nuclear Power Plants: Assessment of Irradiation Embrittlement Effects in Reactor Pressure Vessel Steels

IAEA-TECDOC-1441

### *Effects of nickel on irradiation embrittlement of light water reactor pressure vessel steels*



**IAEA**  
International Atomic Energy Agency

June 2005



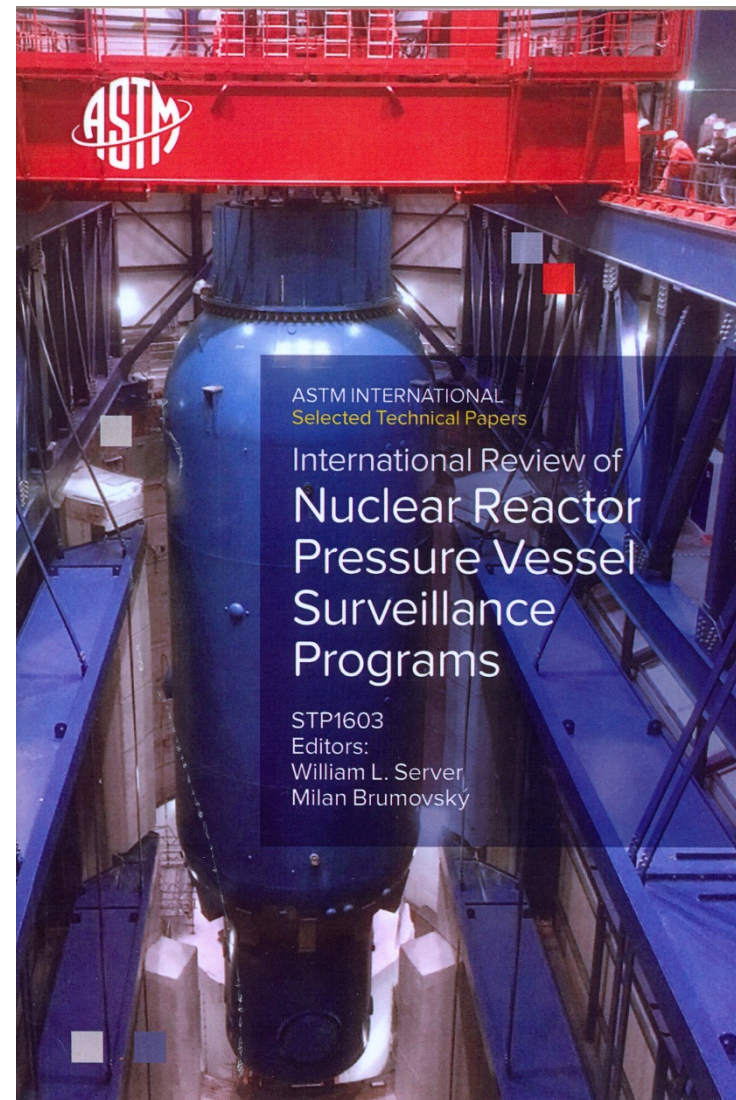
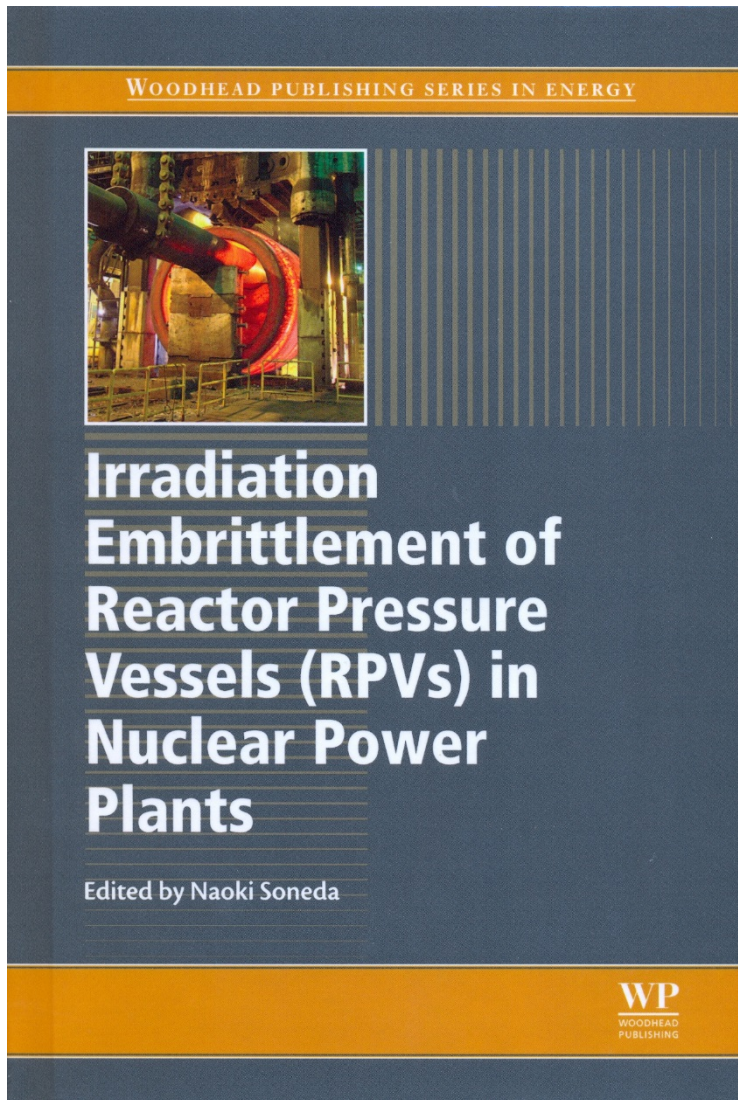



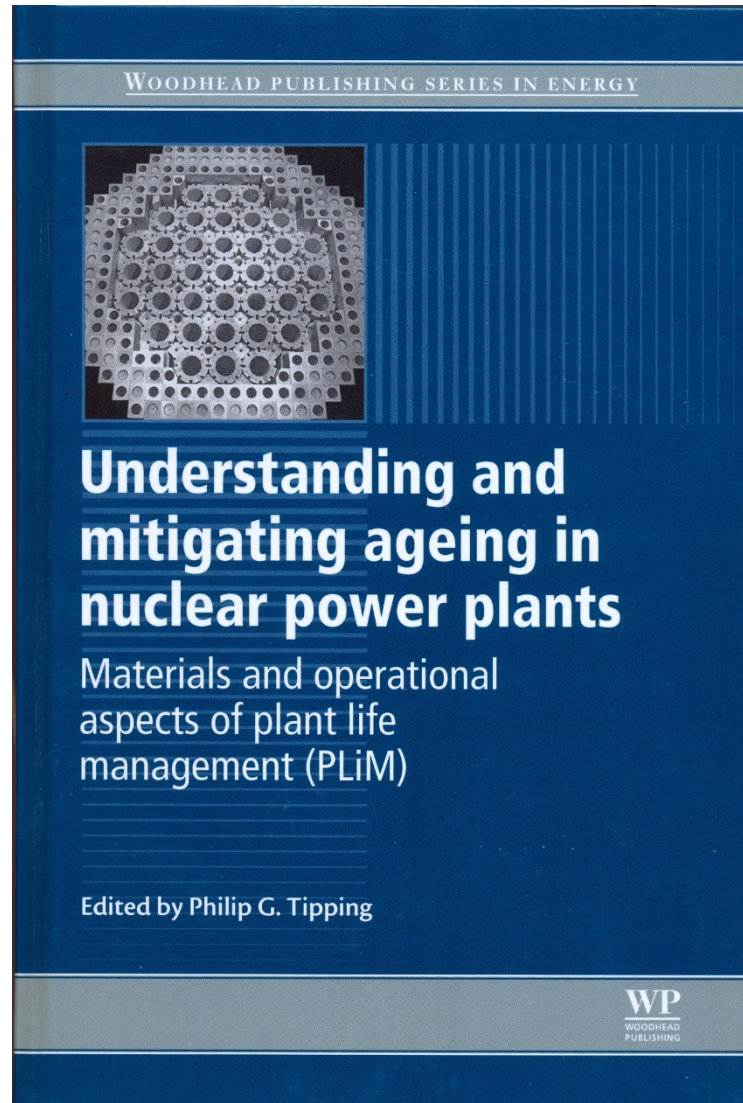

THANK YOU  
ANY  
QUESTIONS,  
PLEASE?

# The SOTERIA Consortium

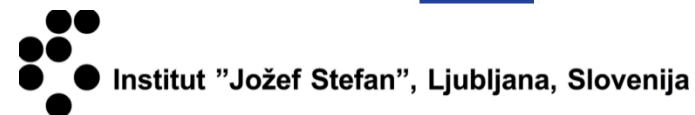
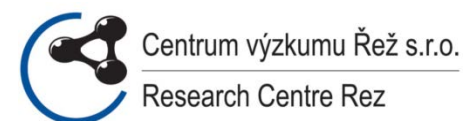

# The SOTERIA Contacts



## The SOTERIA Project Coordinator

Christian ROBERTSON  
CEA  
christian.robertson@cea.fr

## The SOTERIA Project Office

Herman BERTRAND  
ARTIC  
bertrand@artic.eu

[www.soteria-project.eu](http://www.soteria-project.eu)

This project received funding under the Euratom  
research and training programme 2014-2018  
under grant agreement N° 661913.

